



IM KERN DER TECHNIK

Operating Instructions

Series193 Direct Operated Solenoid Valve



Please read these operating instructions carefully to ensure a safe operation and keep the same for further use.

© 2020 Armaturenwerk Altenburg GmbH | Am Weißen Berg 30 | 04600 Altenburg, Germany

Contents

Safety	3
Authorized personnel.....	3
Residual hazards	3
Symbols used for safety information	3
General safety information	4
Other information	5
Description of valve	5
Operating principle	6
Identification.....	6
Technical parameters	7
Approvals and guidelines	8
Design features	9
Housing.....	9
Pilot NC/ NO	9
Solenoid coil	9
Connector plug	10
Service magnet.....	12
Transport and Storage	12
Mounting	12
Principles	12
Mounting preparation.....	14
Mounting of housing on pipe	14
Pilot mounting.....	15
Solenoid Coil mounting.....	15
Connector plug mounting	15
Commissioning	16
Principles	16
Steps of commissioning.....	16
Operation, Maintenance and Repair	17
Operation and maintenance	17
Repair	18
Dismantling and Disposal	19
Principles	19

Safety

The Series193 direct operated solenoid valve, hereinafter referred to as "valve" controls a media flow by means of electronic activation. The valve is a pressure equipment as per EU Directive 2014/68/EU. It is designed for installation into refrigeration systems, in the following referred to "systems", with liquid and gaseous refrigerants and refrigerant oil, in the following referred to as "service fluids". The most significant safety goals as per Article 3, attachment I Low-Voltage Directive 2014/35/EU are met. The valve is no safety component as per Machinery Directive 2006/42/EC.

It may only be put into service if installed unchanged according to the instructions available and as a whole complies with the statutory provisions. The valve incorporates state-of-the-art technology and has been built according to the applicable regulations. Great attention has been set upon the user's safety.

The operating instructions are part of the contract and must be kept accessible to the relevant personnel for the entire service life of the valve.

Authorized personnel

Only trained and instructed personnel shall be allowed to do any work on the valve, system and electrical supply. As regards the qualification and expertise of the personnel the applicable rules and guidelines shall apply.





Residual hazards

Unavoidable residual hazards may emanate from the valve. Every person working on this device shall therefore carefully read these instructions.

To be observed are for example:

- the generally accepted safety regulations,
- EC directives,
- Norms and national directives.

Symbols used for safety information

	DANGER! Instructions on preventing imminent serious dangers to persons. Imminent most serious injuries or death as a possible consequence. Any non-observance may lead to an immediate failure of the valve.
	WARNING! Instructions on preventing potential serious dangers to persons. Avoidable serious to very serious injuries or death as a possible consequence. Any non-observance may cause the valve to fail.
	CAUTION! Instructions on preventing a minor danger to persons. Minor, reversible injuries cannot be excluded. Any non-observance may lead to a medium-term failure of the valve.
	ATTENTION! Instructions on preventing a minor danger to persons. Minor, reversible injuries cannot be excluded. Any non-observance may lead to a medium-term failure of the valve.
	DANGER! Instructions on preventing imminent serious danger to persons. Imminent most serious injuries or death as a possible consequence. Any non-observance may lead to an immediate failure of the valve.

**WARNING!**

Instructions to prevent potential serious hazards to persons.
Avoidable serious to very serious injuries or death as a possible consequence.
Strong magnetic fields.

**CAUTION!**

Instructions to prevent a minor danger to persons.
Minor, reversible injuries cannot be excluded.
Very cold or very hot surfaces possible.

General safety information

These operating instructions are based on the safety requirements of DIN EN 378-2, DIN EN 12284, DIN EN 60730-1, DIN EN 60730-2-8, and DIN EN 60529:2014-09.

Instructions to prevent hazards in all life time cycles.

**DANGER!**

Risk of bursting if operated beyond the technical parameters.
Most serious injuries and immediate system failure possible.
Observe the technical parameters.

**DANGER!**

Electric shock when working on live parts.
Most serious injuries or death possible.
Before working on electrical systems, de-energize lines and check that they are de-energized.

**WARNING!**

Damage due to improper handling.
Serious injuries and system failure possible.
Never use the valves as transport, lifting or lashing points.

**WARNING!**

Any non-observance of the instructions may cause the valve to fail.
Avoidable serious to very serious injuries or death possible.
Installation, operation and maintenance by authorized trained personnel only.

**WARNING!**

Risk of service fluid to be released.
Depending on the kind of service fluid serious to very serious injuries or death possible.
Wear personal protective equipment (e.g. respirators, gloves).

**WARNING!**

Strong magnetic field due to improper handling.
Avoidable serious injuries and system failure possible.
Installation, operation and maintenance by authorized trained personnel only.

**CAUTION!**

Very cold or very hot surface temperatures possible.
Frostbites/burns possible.
Wear personal protective equipment (e.g. gloves, protective clothing).

**ATTENTION!**

Damage of solenoid and pilot possible.
Any non-observance may lead to a medium-term valve failure.
Media and ambient temperature must be observed.

Other information

The information contained herein represents to the best of our belief our knowledge at the time when these instructions were prepared. They shall give you guidance how to safely handle the valve during transport, storage, installation, commissioning, maintenance and dismantling/ disposal. A final decision as to whether the valve suits the purpose is to be taken by the user. This information shall not be deemed a warranty of quality or a guarantee.

Any modification of the valve and its components resp. and operation under other than the prescribed parameters shall not be allowed and will make the declaration of conformity invalid and lead to a loss of all liability claims.

Description of valve

The valve consists of a housing made of steel or stainless steel provided with different connections. The valve seat is integrated in the housing. Various seat diameters are available depending on the application. The armature with integrated valve seat gasket moves in the screwed-on pilot. A solenoid coil is positioned over this pilot which is connected to a connector plug (optionally with cable).

The valve is of modular design. The range of combinations available for the housing with connections, solenoid coil and connector plug can be gathered from the AWA product catalogue.

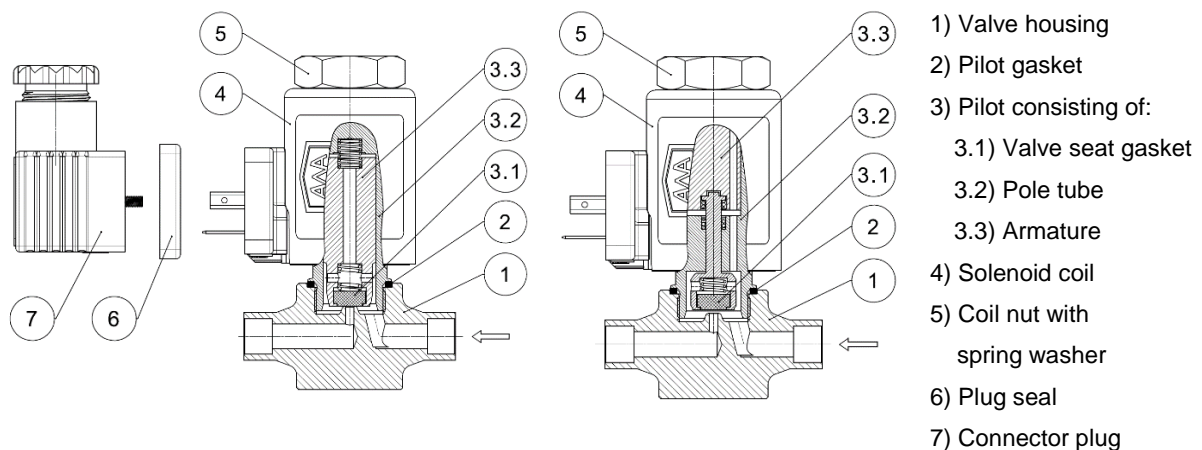

Fig. 1:
Normally closed (NC)

Fig. 2:
Normally open (NO)

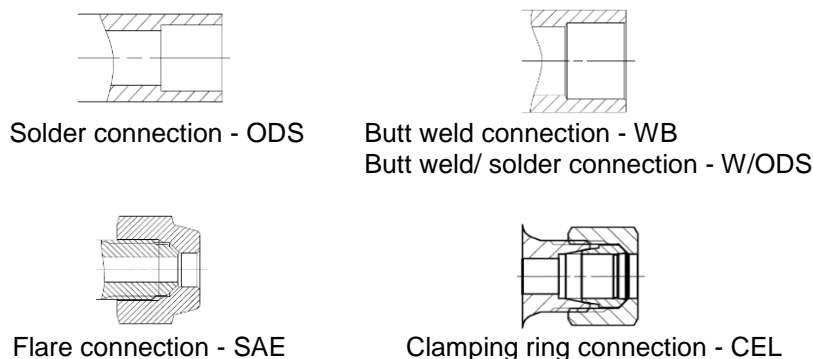

Fig. 3: Housing connections as examples

Operating principle

When voltage is applied the solenoid coil build a magnetic field. The magnetic force thus produced shifts the armature in the pilot and performs the switch function (open/close). As soon as the electric voltage drops the magnetic force drops too, and the armature is shifted to rest position by the return spring.

The through-flow of the valve takes place in flow direction marked by an arrow on the housing. A pressure differential develops between the inlet and the outlet of the valve, see Fig. 1/ Fig. 2.

Identification

The housing and pilot are marked in accordance with the Pressure Equipment Directive 2014/68/EU.

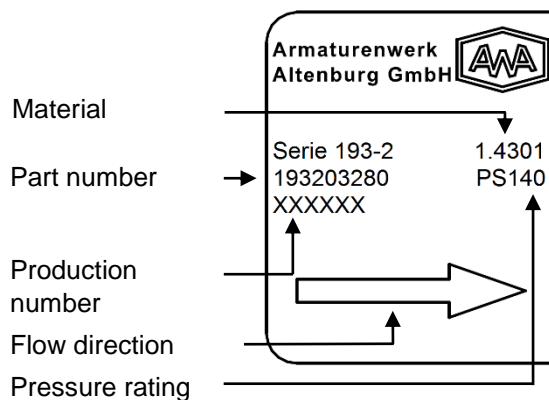

Fig. 4: Marking of valve housing

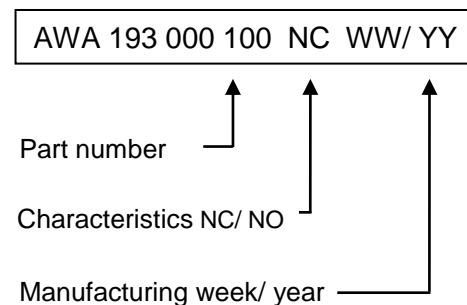

Fig. 5: Marking of pilot

The solenoid coil and connector plug are marked in accordance with the Low-Voltage Directive 2014/35/EC and RoHS Directive 2011/65/EC.

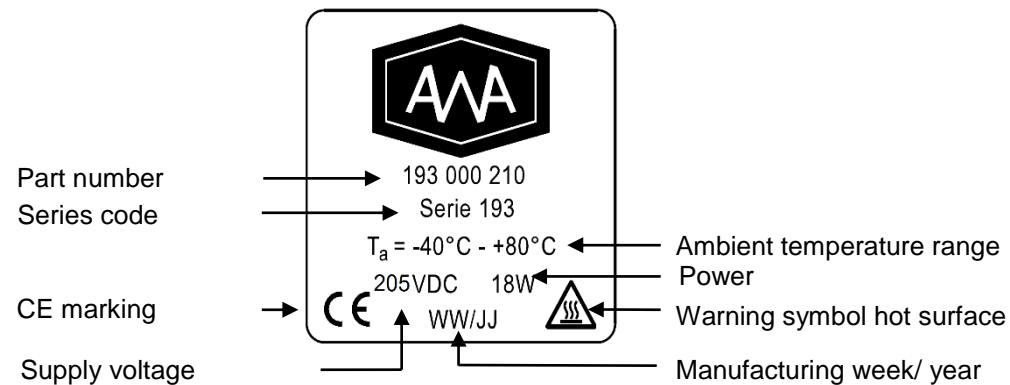

Fig. 6: Marking of solenoid coil

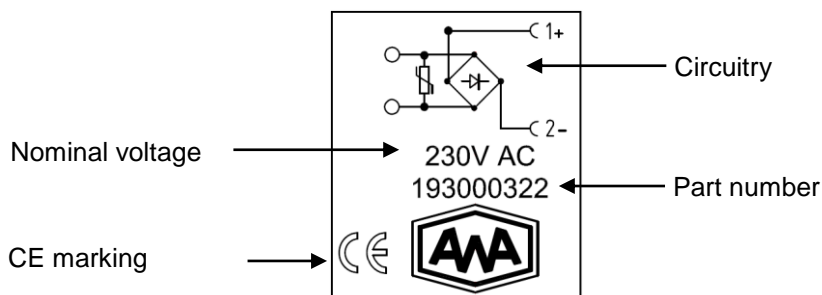

Fig. 7: Marking of connector plug (optional with cable)

Technical parameters

Allowable pressure / service fluids:

see technical documents

Leakage test:

Pilot and steel housing acc. to DIN 8964-3 (<4.1 g/a R-134a at 10 bar)

Stainless steel housing: no test

Strength test:

Pilot and steel housing acc. to DIN EN 12284 at 1.43-fold PS

Stainless steel housing: no test

Cleanliness of the interior:

acc. to DIN 8964-1

Classification as per Pressure Equipment Directive 2014/68/EU:

Article 4 (3)

Solenoid coil with connector plug			
Operating voltage (U _s)	24 V _{DC} ±10 %	110 V _{AC} ± 10 %	230 V _{AC} ± 10 %
Frequency	---	50...60 Hz	50...60 Hz
Electric strength	≥ 1 kV _{AC}	≥ 1.4 kV _{AC}	≥ 2.2 kV _{AC}
Insulation resistance	≥ 100 MΩ		
Prot. cond. resistance	≤ 0.1 Ω		
Electrical power	11 W / 18 W / 52 W	11 W / 20 W	11 W / 18 W
Duty cycle	100 %		
Thermal class	H (DIN EN 60085:2008)		
Plug	2P+E (DIN EN 175301-803 Form A)		
Protective circuitry	Attenuation of voltage peaks upon disconnection by varistor or Z-diode, see data sheet.		

For specifications of versions not listed see technical documents.

Temperature characteristics	
Fluid temperature range (T _s)	-40...140 °C
Ambient temperature range (T _A)	-40...80 °C
Storage temperature range (T _A)	-40...80 °C

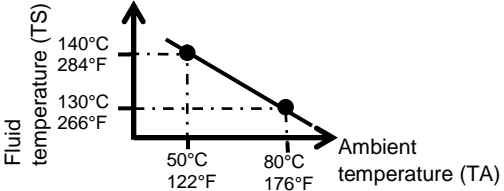

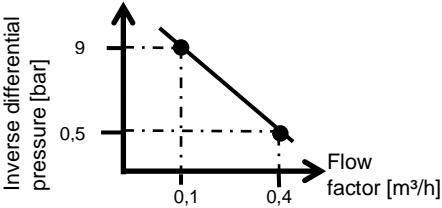
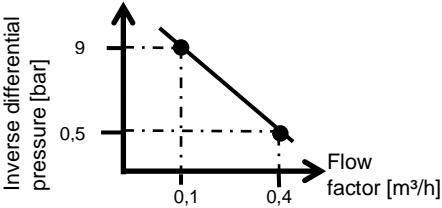
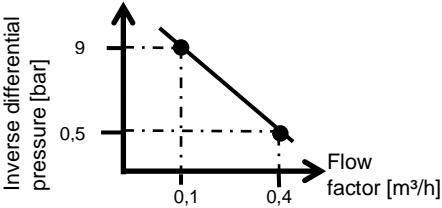
Pressure characteristics				
Vacuum resistance	Yes			
Minimum opening pressure differential (min OPD)	0 bar			
Maximum opening pressure differential (MOPD)	See technical documents			
Maximum reverse pressure differential (MRPD)	Closed valve also seals in case of short-time reversed pressure fluctuation from outlet to inlet.			
	<table border="1"> <tr> <td>NC valve</td> <td rowspan="2">  </td> </tr> <tr> <td>NO valve</td> <td>See technical documents</td> </tr> </table>	NC valve		NO valve
NC valve				
NO valve		See technical documents		
Maximum idle pressure differential (MIPD)	When closed the differential pressure pushes the valve seat gasket into the seat. The maximum non-switching idle pressure differential can be gathered from the technical documents.			

Operating conditions	
Degree of protection	IP 65 (DIN EN 60529) (when installed with original AWA connector plug)
Installation position	any, preferably vertical coil
Material of pilot	steel (surface Zn)

Approvals and guidelines

CE conformity

Pressure Equipment Directive	2014/68/EU
Low-Voltage Directive	2014/35/EU
RoHS Directive	2011/65/EU
EMC Directive	2014/30/EU
Reach Regulation	Regulation (EC) No. 1907/2006

Norms applied

DIN EN 378-2;	DIN EN 60730-1:2017;	DIN EN 60529:1991/A2:2013/AC:2019-02
DIN EN 12284	DIN EN 60730-2-8+A1:2004;	DIN EN 175301-803:2006
	DIN EN 60085:2008	

Design features

The material of the components and the manufacturing methods have been selected in conformity with the guidelines and norms mentioned above thus guaranteeing the reliability for the operating range indicated.

Housing

The valve housing is made of galvanized steel or stainless steel (1.4301 / 1.4307). The valve seat is located in the housing. The latter can be provided with different connections, ref. Fig. 3. The flow direction is marked by an arrow on the housing.

Pilot NC/ NO

The pilot consists of a pressurized pole tube of galvanized steel. It houses the magnetically movable armature and the spring-damped valve seat gasket. The latter seals the valve seat in the housing. The armature can be arranged so that the valve is closed (NC – normally closed) or opened (NO – normally open) in de-energized state ref. Fig. 1/ Fig. 2. The movable armature is protected in the pilot against falling out.

Solenoid coil

The solenoid coil is plugged over the pilot and secured by the attached spring washer and coil nut. The current-carrying coil builds a magnetic field which is strongest inside. This magnetic field exerts a magnetic force on the armature in the pilot and shifts the same. Fluid temperatures of up to 140 °C and the electrical power loss heat the coil winding up to 180 °C max. The outer metal casing is to cool the solenoid coil and serves for electromagnetic shielding.

Solenoid coils of the Series193 use d.c. voltage. For valve operation by a.c. voltage, e.g. 110 V_{AC} or 230 V_{AC} the AWA connector plug of the Series193 comes with rectifiers transforming the a.c. voltage at the input side into a direct voltage, ref. Fig 13. Solenoid coils for the rated voltage 110 V and 230 V are therefore dimensioned in pairs with the connector plug in accordance with the rectified values listed below. The intended operation of solenoids of the performance class above 20 W requires the use of the Series193 connector plug with energy efficiency circuit.

Rated voltage	Input Series193 connector plug	Input Series193 solenoid coil
24 V	24 V _{DC} ± 10%	24 V _{DC}
110 V	110 V _{AC} ± 10% @ 50...60 Hz	97 V _{DC}
230 V	230 V _{AC} ± 10% @ 50...60 Hz	205 V _{DC}

Table 1: Rectified values of Series193 solenoid coil



Fig. 8: Connector plug of solenoid coil
DIN EN 17503-830 Form A

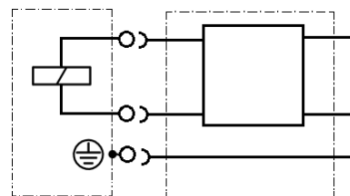

Fig. 9: Connection diagram of
solenoid coil with connector plug

Connector plug

The connector plug (2P+E) has been designed in accordance with DIN EN 175301-803 Form A ref. Fig. 8. Together with the seals at the plug connection, the central screw and, if available, the cable gland it ensures the degree of protection and the reliability within the area of application.

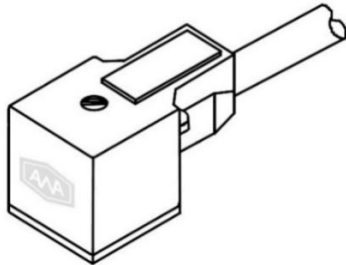

Fig. 10: Connector plug with cable

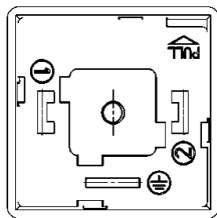

Fig. 11: Connector plug layout

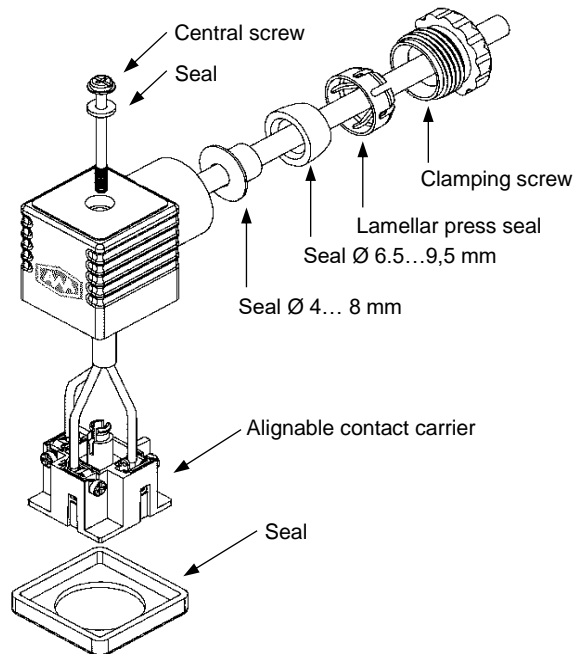
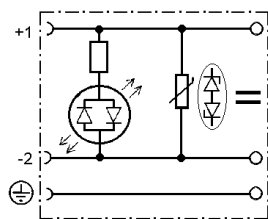
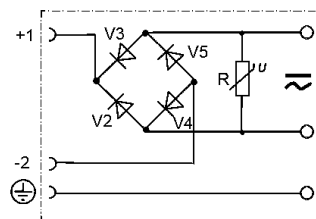

Fig. 12: Connector plug without cable



Overvoltage protection circuit, LED



Rectifier, overvoltage protection LED, Energy efficiency circuit

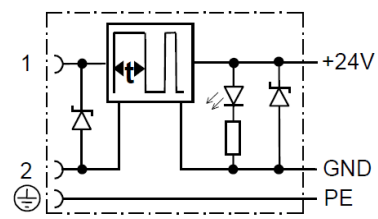

LED, Energy efficiency circuit, overvoltage protection circuit

Fig. 13: Connector plug circuitry

Rectifier

The Series193 connector plug of 110 V and 230 V rated voltage houses an electronic rectifier transforming the a.c. voltage into d.c. voltage. The connector plugs and solenoids of the Series193 are geared to each other in terms of design, ref. Table 1.

Overvoltage protection circuit

The solenoid coil is an inductive component. When switched off it induces a switch-off voltage for a short time being many times higher than the mains voltage. Without a proper protective circuit such voltage peaks have an impact on the control system. It may cause major consumption and thus early wear of the switching contacts. Additionally, capacitive couplings may cause fault signals and destructions.

To avoid such adverse effects, the solenoid coils with connector plugs of the Series193 are provided with a protective circuit to dissipate such kind of induced voltage peaks.

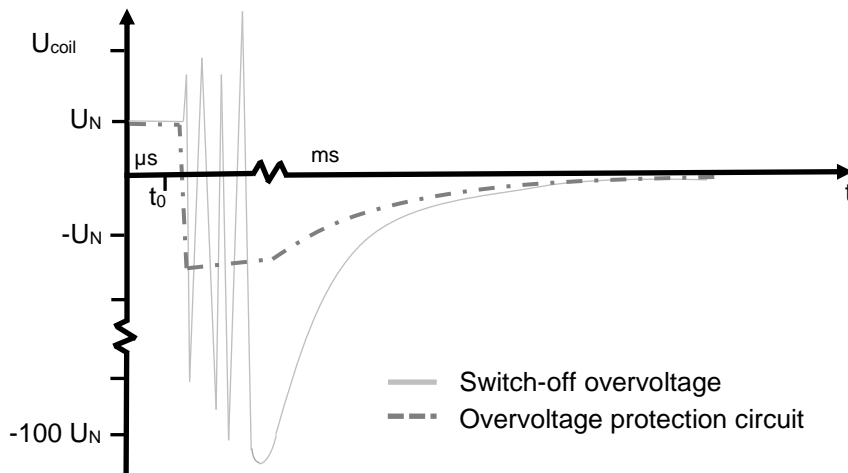

Fig. 14: Limitation of switch-off voltage by overvoltage protection circuit

Energy efficiency circuit (applicable for NC pilot only)

For the switching operation proper of the pilot a much higher magnetic force is needed compared with that to maintain the open valve state.

The optional Series193 connector plug with energy efficiency circuit uses this effect. During the switching operation it supplies the solenoid with 100 % electric power and reduces it as soon as the valve is open. Upon reduced magnetic force the armature is now safely kept in the open valve position.

The reduced power input lowers the coil temperature in continuous operation, the power consumption and at the same time increases the service life.

For the operation of solenoid coils above 20 W it is mandatory to use connector plugs with energy efficiency circuit.

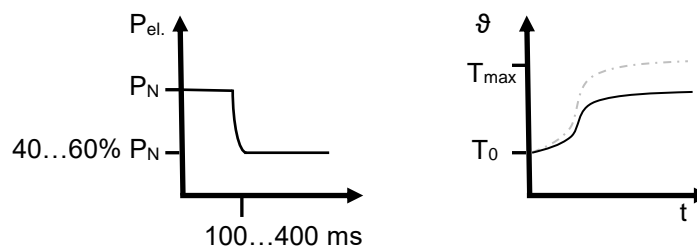

Fig. 15: Performance reduction with energy efficiency circuit

Service magnet

The service magnet consists of jacketed permanent magnets. Due to the design the magnetic field is stronger inside the service magnet and weaker outside. The service magnet is arranged over the pilot thus shifting the armature in the pilot and performing the switching function (open/close).

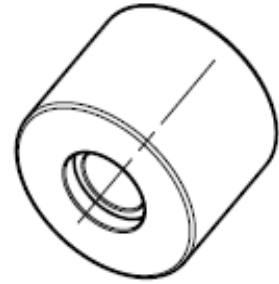

Fig. 16: Service magnet

	WARNING! Strong magnetic field. Avoidable serious to very serious injuries or death possible. Wear personal protection equipment, keep minimum distances!
--	---

	WARNING! Strong magnetic field. Attracts magnetizable objects, damage to electronics possible. Wear personal protection equipment, keep minimum distances!
--	--

Transport and Storage

Transport the components of the valve by closed means of transport in the original packaging protected against weather influences and store in dry rooms.

The valve comes unassembled. Pilot, solenoid and connector plug are protected by individual packaging.

Mounting

Principles

The valve shall be arranged in the system so that it can be properly operated and maintained. Also make sure that loads from the piping are not transmitted to the valve.

	DANGER! Damage to valve possible. Serious injuries and system failure during operation as possible consequences. Valve to be installed without additional loads (forces, vibrations etc.)
--	---

The valve shall be integrated into a pipe on both sides. An outlet open to the outside is not allowed.

Foreign matter in the service fluid may cause damage and malfunctions. The use of a strainer is recommended for a safe connection.

The solenoid coil and the connector plug emit heat to the environment for cooling. Therefore, a reasonable space should be kept around them. It is not allowed to insulate the solenoid coil, connector plug or cable.

The mounting space should be selected so that the valve can be properly installed by means of tools and with the necessary torque as given in the table below.

Component	Torque Nm
Pilot	55+5
Coil nut	6+1
Fastening screw of connector plug	0.5
Clamping screw of connector plug	0.5
Cable gland of connector plug	1.8

Table 2: Torques for valve installation



Fig. 17: Mounting

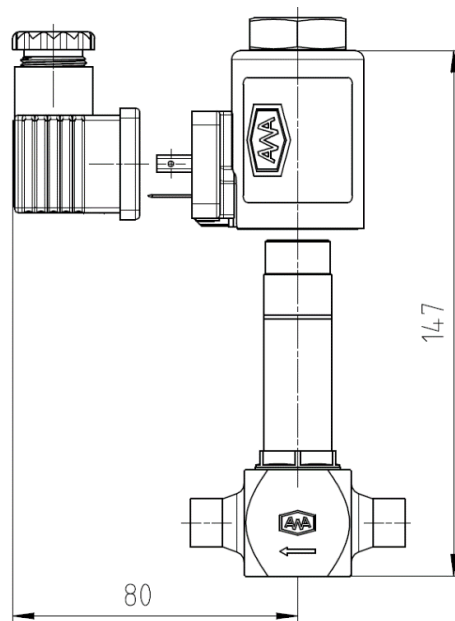

Fig. 18: Minimum mounting space of solenoid coil and connector plug

Mounting and electrical installation must be reserved to trained specialists with a sound mechanical and electrical knowledge.

	<p>DANGER! Any non-observance of these instructions may cause the valve/ system to fail. Most serious injuries and death possible. Mounting and operation by personnel trained in refrigeration systems only.</p>
--	--

	<p>DANGER! Any non-observance of these instructions may cause the valve/ system to fail. Most serious injuries and death possible. Mounting and operation by electrical specialists only.</p>
--	--

No modifications of the valve are permitted. If modifications become necessary, they have to be agreed with the manufacturer in writing prior to mounting.

	<p>WARNING! Product features may change. Avoidable serious to very serious injuries or death as possible consequence. Any modification of the valve has to be agreed with manufacturer beforehand.</p>
--	---

Mounting preparation

When supplied the valve components come separately packaged with additional protective means for transport. To avoid damage, corrosion inside the valve and contamination, such protective means should be removed shortly before mounting.

The components shall be checked for completeness. All sealing surfaces, sealants and threads must be checked for cleanness and intactness.

	ATTENTION! Malfunction due to oxidation/ contamination of internal components. Possible damage to interior components. Wait to remove the transport protection until shortly before mounting.
---	---

Observe the mounting sequence:

1. Mounting of housing to pipe
2. Pilot mounting
3. Solenoid coil mounting
4. Connector plug mounting

Mounting of housing on pipe

Weld-solder connection

The pipe must be of a dimension that fits the valve. If not, use adapters.

Prepare the system connections so (metallically bright and grease-free) that a high-quality joint can be made. Provide for a mechanically unrestrained mounting.

While brazing and welding scavenge relevant pipe section with shielding gas. A cooling of the steel valve body is recommended. After that allow the system connection to cool down in the air.

	WARNING! Damage to the valve housing due to excessive heating possible. Serious injuries and system failure during operation possible. Keep the heat source away from the valve housing.
---	--

	WARNING! Damage to the valve housing due to rapid cooling possible. Serious injuries and system failure during operation possible. Allow joint to cool in the air.
---	--

	ATTENTION! Malfunction due to oxidation of internal components. Damage to internal components possible. Scavenge with shielding gas while doing the joining.
---	--

Clean the pipe connections made. Flux residues from brazing are very corrosive and may cause long-term damage. For stainless steel valves observe the general rules to maintain the material properties (e.g. cleaning, passivation, tool selection).

	CAUTION! Risk of increase corrosion and component damage. Serious injuries and system failure during operation possible. Properly clean the joint after joining.
---	--

Detachable threaded connection

When making the screwed connection it is essential that the connections match in terms of type and dimension and the necessary sealing elements are used.

Attention must be paid to a mechanically unrestrained mounting. Strictly observe the torques of the relevant screwed connection and specifications of the cutting ring manufacturers. When it comes to screwed stainless steel connections it is in particular necessary to observe the general technical rules to avoid fretting (use release agents).



WARNING!

Any excessive torques or non-observance of the mounting sequence may cause failures that may occur later.
 Serious injuries and system failure during operation possible.
 Observe the torques and mounting sequence.

Pilot mounting

After joining it is necessary to ensure the cleanliness and freedom from damage of the housing interior, valve seat, housing sealing surface, pilot sealing surface and pilot sealing. The pilot must be fastened to the valve housing by means of the attach pilot sealing. Attention should be paid to an alignment with the threaded connection of the housing. Initially the pilot must be screwed into the housing by hand and then uniformly tightened applying the torque given in Table 2.



WARNING!

Any excessive torques or non-observance of the mounting sequence may cause failures that may occur later.
 Serious injuries and system failure during operation possible.
 Observe the torques.

Solenoid Coil mounting

Before the solenoid coil is mounted it must be made sure that it matches with the operating voltage and valve specification. It is to be pushed over the pilot and fastened by means of the spring washer and coil nut, ref. Fig. 17, applying the torque listed in Table 2. The coil shall be aligned according to the system requirements with sufficient space around it for heat dissipation.



WARNING!

Any excessive torques or non-observance of the mounting sequence may cause failures that may occur later.
 Serious injuries and system failure during operation possible.
 Observe the torques.

Connector plug mounting

The operating voltage must comply with the admissible rated voltage and frequency of the solenoid coil. Before mounting the line must be de-energized and checked for zero potential. The entire wiring must be in line with the local regulations and made according to the relevant wiring diagram. Observe the relevant safety regulations when the cable is connected to the control system.



DANGER!

Any non-observance of these instructions may cause the valve/system to fail.
 Most serious injuries and death possible.
 Only electricians shall be allowed to work on the electrical systems.

Connect a cable to the connector plug without cable that suits the operating conditions. The plug components must be arranged as given in Figure 12.

Before the connector plug is mounted to the solenoid coil check the cable and plug for any damage. Protect the electrical connections against penetrating moisture.

Attach the connector plug and the plug seal to the solenoid coil and then tighten it applying the torque listed in Table 2.

	WARNUNG! Any non-observance of the torques may cause failures. Serious injuries and system failure during operation possible. Observe the torques.
---	--

Commissioning

Principles

The steel valve and pilots have already been tested for leakage and strength by the manufacturer.

The valve and the system into which it is installed, may only be commissioned if they have been checked, with due regard to the intended mode of operation, for proper condition as to assembly, installation, set-up conditions and safe functioning.

After complete mounting and prior to initial start-up, check the valve and the system according to DIN EN 378-2:2016 for leakage and strength and effective corrosion protection. The valve shall be in open position.

Steps of commissioning

Check the system for leakage and pressure resistance by suitable means (e.g. helium, dry nitrogen).

	DANGER! Risk of valve bursting. Most serious injuries possible. The test pressure must not exceed the maximum allowable pressure (PS). Strictly observe the safety regulations (e.g. DIN EN 378).
---	--

	ATTENTION! Irreversible damage to valve seat gasket possible. System failure during operation possible. The test pressure must not exceed the maximum allowable pressure (PS).
---	--

The application of a corrosion protection suitable for the operating conditions is in any case necessary for valves made of steel (Series193-1) and may be required for stainless steel valves (Series193-2). Make sure that the manufacturer's information remains legible.

CAUTION!

Delayed failure due to corrosion possible.
 Serious injuries and system failure during operation possible.
 Application of suitable corrosion protection necessary.

ATTENTION!

Loss of product conformity if lettering is removed/hidden.
 Loss of warranty.
 Lettering must remain legible.

Evacuating and filling the system with service fluids. The valve must be in open position.

DANGER!

Risk of bursting if operated beyond the technical parameters.
 Most serious injuries possible.
 Observe the technical parameters of the valve.

WARNING!

Any non-observance of the torques may cause failures.
 Serious injuries and system failure during operation possible.
 Observe the torques.

Upon initial commissioning check the pipes for any abnormal vibration and record the operating data.

CAUTION!

Cracks of piping and valve due to vibrations possible.
 Injuries and system failure during operation possible.
 Avoid heavy vibrations. Take safety measure if need be.

Check current-carrying components for freedom from damage. Make sure the connector plug and solenoid coil are properly installed.

DANGER!

Electric shock due to improper insulation and breakage of live components.
 Most serious injuries and death as possible consequences.
 Replace defective parts immediately.

ATTENTION!

Connector plugs must be de-energized when attached or removed.
 Damage to connector plug and solenoid coil possible.
 Any non-observance may cause the valve to fail in the medium run.

WARNING!

Solenoid coils may only be operated if correctly mounted.
 Any non-observe lay lead to damage and attraction of neighbouring parts.
 Serious injuries and system failure possible.

Operation, Maintenance and Repair

Operation and maintenance

The valve is maintenance-free.

As part of the regular system inspection it should be checked for corrosion/ damage and operability and its proper condition restored if necessary. The cause of damage shall be eliminated to ensure the intended function.

The service magnet of the Series193 is used to actuate the pilot without operating voltage.

	WARNING! Media contact possible, contact with hot/cold surfaces. Burns/frostbites Wear personal protective equipment during maintenance and inspections as prescribed by national regulations.
---	--

	CAUTION! Very high surface temperature of solenoid coil possible Burns are possible. Wear personal protective equipment (e.g. gloves)!
---	--

	DANGER! Electric shock due to improper insulation and breakage of live components. Most serious injuries and death as possible consequences. Replace defective parts immediately.
---	---

Repair

De-energize lines and components before working on it and check that they are voltage-free.

	DANGER! Electric shock when working on live components. Most serious injuries and death as possible consequences. De-energize lines before working on electrical system and check for relevant condition.
---	---

If it is necessary to remove the solenoid coil for repair purposes, carefully loosen the coil nut. If in doing so the pilot comes off from the valve housing, tighten it again immediately and provisionally restore the system tightness. In such case and also if the intended function of the valve can no longer be guaranteed, de-pressurize the system section, remove the service fluids in an eco-friendly manner and ventilate the section sufficiently.

	DANGER! Service fluids may escape. Leaking service fluids may cause most serious injuries. For repairs the system must have the right temperature, free of any service fluid and sufficiently ventilated.
---	---

Installation and re-commissioning must take place in accordance with these operating instructions. It is essential to carry out a repeated leakage and strength test.

Always use a new seal ring to fasten the pilot to the housing.

Always use original AWA spare parts for repairs. For the relevant spare part numbers see the technical documents.

	WARNING! Valve damage due to faulty spare-parts /installation. Avoidable serious injuries and system failure possible. Use no other than original AWA spare parts for repairs.
---	--



Dismantling and Disposal

Principles

De-energize electric lines and components before working on it and check the relevant condition.

For dismantling de-pressurize the system section, remove the service fluids in an eco-friendly manner and ventilate the section sufficiently.

**DANGER!**

Service fluids may escape.

Leaking service fluids may cause most serious injuries.

For repairs the system must have the right temperature, free of any service fluid and sufficiently ventilated.

The valve and its components can be recycled:

Housing:	steel / stainless steel scrap
Pilot:	steel scrap
Solenoid coil:	electronic waste
Connector plug / cable:	electronic waste
Dust cap:	plastics (PE)



Armaturenwerk Altenburg GmbH

Am Weißen Berg 30
04600 Altenburg

Telephone +49 (0) 3447-893-0
Telefax +49 (0) 3447-811-10

Internet: <http://www.awa-armaturenwerk.de>
E-Mail: info@awa-armaturenwerk.de

Subject to change as of: 11.2020
Document 90000728 Revision 00