



Operating Instructions  
in compliance with  
Pressure Equipment Directive 2014/68/EU

Series882 Check Valve RDL



Please read these operating instructions carefully to ensure a safe operation and keep the same for further use.





## Contents

Safety.....	4
Authorized personnel.....	4
Residual dangers.....	4
Symbols used for safety information .....	4
General safety information .....	5
Other information .....	5
Description of valve .....	6
Types .....	6
Operating principle .....	6
Product description .....	6
Identification .....	7
Technical parameters .....	7
Design features .....	8
Transport and Storage.....	9
Mounting .....	9
Principles .....	9
Mounting preparation.....	9
Connecting the pipe.....	9
Commissioning .....	10
Principles .....	10
Steps of commissioning.....	10
Operation, Maintenance and Repair .....	11
Principles .....	11
Repair .....	12
Dismantling and Disposal .....	12
Principles .....	12

## **Safety**

The Series882 check valve RDL, hereinafter referred to as valve, is designed for use in refrigeration/air conditioning systems referred to as systems hereinafter. It may only be put into service if installed into the system unchanged in accordance with these instructions and as a whole is compliance with the statutory provisions.

The valve incorporates state-of-the-art technology and has been built according to the applicable regulations. Great valve has been set upon the user's safety.

Keep these operating instructions throughout the entire life of the valve.

### **Authorized personnel**

Only trained and instructed personnel shall be allowed to do any work on the valve and system. As regards the qualification and expertise of the personnel the applicable rules and guidelines shall apply.





### **Residual dangers**

Unavoidable residual dangers may emanate from the valve. Every person working on this device shall therefore carefully read these instructions!

To be observed are for example:

- the generally accepted safety regulations,
- EC directives,
- Norms (e.g. EN 378) and all national provisions.





### **Symbols used for safety information**

	<b>DANGER!</b> Instructions on preventing imminent serious danger to persons. Imminent most serious injuries or death as a possible consequence. Any non-observance may lead to an immediate failure of the valve.
	<b>WARNING!</b> Instructions on preventing potential serious danger to persons. Avoidable serious to very serious injuries or death as a possible consequence. Any non-observance can cause the valve to fail.
	<b>CAUTION!</b> Instructions on preventing a minor danger to persons. Minor, reversible injuries cannot be excluded. Any non-observance may lead to a medium-term failure of the valve.
	<b>ATTENTION!</b> Instructions on preventing potential damage to equipment. Minor, reversible injuries cannot be excluded. Any non-observance may lead to a medium-term failure of the valve.

## General safety information

These operating instructions are based on the safety requirements of DIN EN 378-2 and DIN EN 12284.

Instructions to prevent hazards in all cycles of service life:

	<p><b>DANGER!</b>            Risk of bursting if operated beyond the technical parameters.            Most serious injuries and immediate system failure possible.            Observe the technical parameters.</p>
	<p><b>WARNING!</b>            Damage due to improper handling.            Serious injuries and system failure possible.            Never use the valve as transport, lifting or lashing point.</p>
	<p><b>WARNING!</b>            Risk of bursting in an environment causing stress corrosion cracking.            Most serious injuries and immediate system failure possible.            Observe the environmental conditions for stainless steel 1.4301/1.4307!</p>
	<p><b>WARNING!</b>            Any non-observance of the instructions may cause the valve to fail.            Avoidable serious to very serious injuries or death possible.            Installation, operation and maintenance by authorized trained personnel only.</p>
	<p><b>CAUTION!</b>            Very cold or very hot surface temperatures possible.            Frostbites/burns possible.            Wear personal protective equipment (e.g. respirators, gloves).</p>

## Other information

The information contained herein represents to the best of our belief our knowledge at the time when these instructions were prepared. They shall give you guidance how to safely handle the valve during transport, storage, installation, commissioning, maintenance and dismantling/disposal. A final decision as to whether the valve suits the purpose is to be taken by the user. This information shall not be deemed a warranty of quality or a guarantee.

Any modification of the valve and operation under other than the prescribed parameters shall not be allowed and will result in the loss of the conformity declaration and all liability claims.

## Description of valve

### Types

Connection A: Valve with DHP-copper tubes and brazed connections ODS

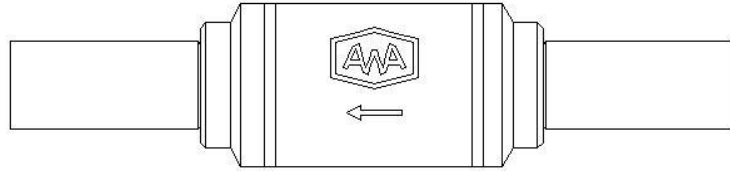

Connection B: Valve with stainless-steel tubes and weld / brazed connections W / ODS

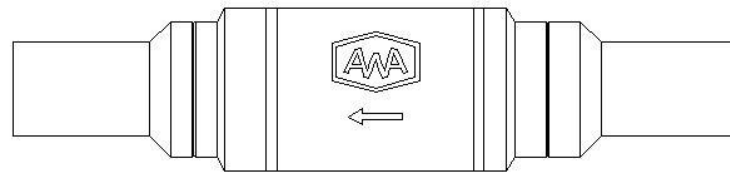

Installation dimensions can be gathered from the AWA product catalogue and technical documents respectively. The connecting options A and B are explained in more detail in "Design features".

### Operating principle

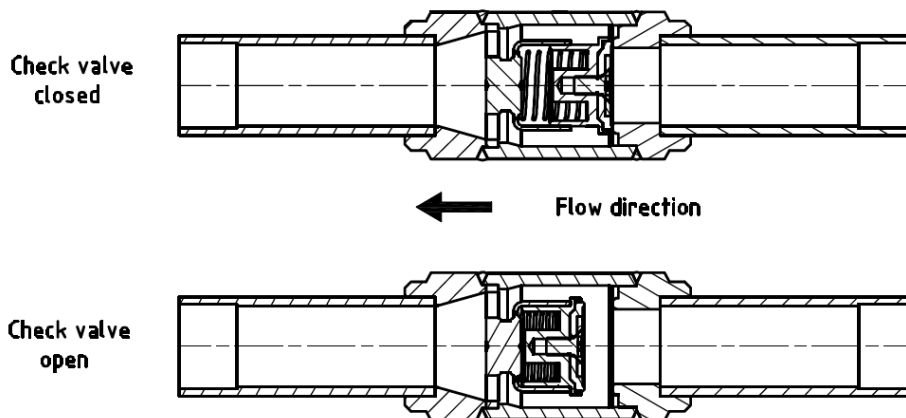

### Product description

The Series 882 check valve RDL is a damped check valve for refrigeration or air conditioning systems. The valve can be used in all system sections (suction pipe, discharge pipe) also for pulsating media.

The low opening pressure differential (approx. 0.03bar) provides for high response sensitivity in closing and opening direction. Other opening pressure differentials are possible on request.

The arrow, permanently marked on the valve body, indicates the flow direction.

The valve is in compliance with DIN EN 12284:2003 and Pressure Equipment Directive 2014/68/EU.

## Identification

The valve is marked by name plate and marking in accordance with DIN EN 12284 on the valve body as follows:

- Manufacturer's logo, Type designation
- Arrow for flow direction
- Nominal diameter in mm, allowable pressure in bar, allowable temperature in °C
- Date of manufacture, Materials
- CE mark with ID number of notified body for valves of category II

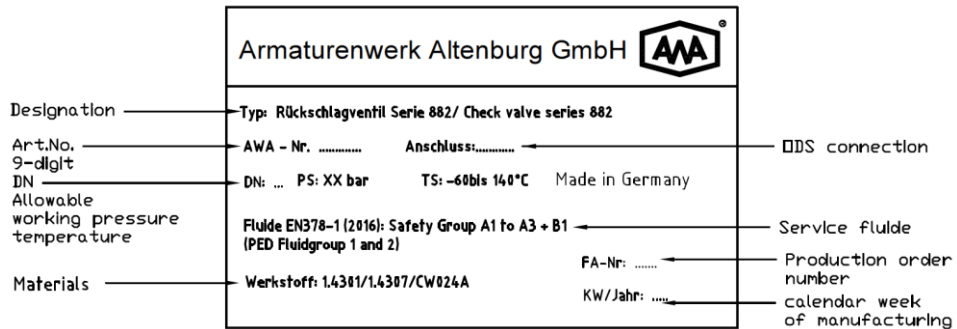

## Technical parameters

### Pressure / Temperature allocation / Classification pursuant to Pressure Equipment Directive (PED 2014/68/EU) / Service fluids:

Maximum allowable pressure: PS [shown in table]

Allowable temperature: TS -60 to 140°C

- A) Valves with copper tubes and brazed connections:  
 Allowable fluids: Refrigerants acc. to DIN EN 378-1 (2016):  
 Safety Group A1 to A3 and B1 (PED Fluid Group 1 and 2)

Dimension Brazed connection mm [inch]	Part number PS 45bar	Part number PS 63bar	Classification PED 2014/68/EU
ODS 12	882001000	882101000	Artikel 4(3)
ODS [1/2"]	882002000	882102000	
ODS 16 [5/8"]	882003000	882103000	
ODS 18	882004000	882104000	
ODS [3/4"]	882005000	882105000	
ODS 22	882006000	882106000	
ODS [7/8"]	882007000	882107000	
ODS 28	882008000	---	
ODS [1 1/8"]	882009000	---	Kategorie II
ODS 35 [1 3/8"]	882010000	---	

- B) Valves with stainless-steel tubes and weld / brazed connections:  
 Allowable fluids: Refrigerants acc. to DIN EN 378-1 (2016):  
 PED Fluid Group 1 and 2

Dimension Weld connection	Dimension Brazed connection	Part number PS 140bar	Classification PED 2014/68/EU
W 13,5	ODS 3/8"	882201000	Artikel 4(3)
W 17,2	ODS 1/2"	882202000	
W 22	ODS 5/8"	882203000	

On request other refrigerants can be permitted. It is explicitly indicated in the technical documentation.

**Opening pressure differential:**

As standard the opening pressure differential is about 0.03 bar.  
Other opening pressure differentials are possible on request.

**Leakage test (external):**

according to DIN 8964-3 (<4.1 g/a R-134a at 10bar)

**Strength test:**

according to DIN EN 12284 at 1.43-fold PS

**Cleanliness of interior:**

according to DIN 8964-1

## **Design features**

- The material of the valve components and the manufacturing method are selected in conformity with the EN12284:2003, Pressure Equipment Directive 2014/68/EU and RoHS Directive 2011/65/EU thus guaranteeing the reliability for the operating range indicated.
- The stainless steel housing material (double certification 1.4301 and 1.4307) ensures a maximized media compatibility and corrosion resistance.
- The hermetic connection of the pressure-bearing housing and connection parts ensures a maximum protection against external leaks.
- The valve comes with plastic to metal sealing. The valve seat and seat gasket are precision-machined and thus designed for a long service life. The valve is spring-loaded and has an absorption component. The vibration of the valve is thus largely avoided when pulsating media are used.
- Very small spring constants ensure a high response sensitivity in closing and opening direction as well as low pressure losses in flow-through state.
- Types of connection:

**Connection "A"** – Brazed capillary connection to render a brazed joint with copper pipes according to DIN EN 12735-1 for dia. 12 to 35mm and relevant inch dimensions. Designed as connection for insertion of a copper pipe (ODS).

Abbreviated designation: ODS xx (xx stands for relevant outside diameter in mm or inch).

**Connection "B"** – Welded connection for use of pipes according to DIN EN 10220 and relevant inch-type dimensions. Designed as butt-welded connection (W).

Additional with Brazed capillary connection to render a brazed joint with copper pipes for dia. 3/8", 1/2" and 5/8" (ODS).

Abbreviated designation: W xx / ODS yy (xx stands for relevant outside diameter of the steel pipe and yy stands for relevant outside diameter of copper pipe)



## Transport and Storage

Transport the valve by closed means of transport in the original packing protected against weather influences and store it in dry areas.

## Mounting

### Principles

- The valve shall be arranged in the system so that it can be properly operated and maintained.

	<p><b>DANGER!</b>          Damage of valve possible.          Serious injuries and system failure possible during operation.          Valve to be installed without additional loads (forces, vibrations, etc.).          Shut-off valves must not be used as fixing points of pipes.</p>
---	---

- Only authorized personnel shall be allowed to mount the valve. Observe the flow direction.

	<p><b>DANGER!</b>          Any non-observance of these instructions may cause the valve/system to fail.          Most serious injuries and death possible.          Mounting and operation by personnel trained in refrigeration systems only.</p>
---	--

- No modifications of the valve permitted. If modifications become necessary, they have to be agreed with the manufacturer prior to mounting.

	<p><b>WARNING!</b>          Product features may change.          Avoidable serious to very serious injuries or death possible.          Any modification of the valve has to be agreed with manufacturer in advance.</p>
---	---

- An optimal functionality of the shut-off action is achieved in vertical mounting position with incident flow from below. A horizontal mounting position of the check valve is also possible.

### Mounting preparation

- When supplied the valve is closed and may come with additional protective means for transport. To avoid corrosion inside the valve and contamination, such protective means should be removed shortly before mounting.

	<p><b>ATTENTION!</b>          Possible damage of interior components.          Malfunction due to contamination of internal components.          Remove the transport protection shortly before mounting.</p>
---	---

### Connecting the pipe

1. The pipe must be of a dimension that fits the valve. If not, use adapters.
2. While mounting observe the flow direction of the valve (marked by arrow).
3. Prepare the system connections so (bare metal and free from grease) to achieve a high-quality joint.

- While brazing and welding scavenge the relevant pipe sections with shielding gas. A cooling of the valve body is necessary. Then, cool down the system connection in the air.

**WARNING!**

Damage of valve due to strong heating possible.  
 Serious injuries and system failure possible during operation.  
 Do not heat the system connection above 700°C and valve body above 200°C.  
 Keep the flame away from the valve body.

**WARNING!**

Damage of valve (e.g. cracks) due to rapid cooling possible.  
 Serious injuries and system failure during operation possible.  
 Allow the joint to cool down in the air.

**ATTENTION!**

Damage of internal components possible.  
 Malfunction due to oxidation / dama of internal components.  
 Scavenge with shielding gas while doing the joining.

- Clean the pipe connections rendered. Flux material residues are very corrosive and may cause long-term damage.

**CAUTION!**

Risk of increased corrosion and component damage.  
 Serious injuries and system failure possible during operation.  
 Properly clean the joint after joining.

- If sub-assemblies are to be mounted, protect the pipe ends by dust caps until further use.

## Commissioning

### Principles

- The valve has already been tested for leakage and strength by the manufacturer.
- The valve and the system into which it is installed, may only be commissioned if they have been checked, with due regard to the intended mode of operation, for proper condition as to assembly, installation, set-up conditions and safe functioning.
- After mounting and prior to initial start-up the system shall be checked again for any leakage and strength by the end user in accordance with DIN EN 378-2:2012.

### Steps of commissioning

- After mounting and initial start-up according to DIN EN 378-2:2012 check again for leakage and strength.



**DANGER!**

Danger of bursting.  
 Most serious injuries possible.  
 The test pressure must not exceed the maximum allowable pressure (PS).  
 Strictly observe the safety information (e.g. DIN EN 378).

2. Evacuating and filling the system with refrigerant.

	<p><b>DANGER!</b>            Danger of bursting if operated beyond the technical parameters.            Most serious injuries possible.            Observe the technical parameters of the valve.            Make sure the system is not filled with an excessive amount of refrigerant.</p>
---	--

3. Upon initial commissioning check the pipes for any abnormal vibration and record the operating data.

	<p><b>CAUTION!</b>            Cracks of the piping and the valve due to dynamic loads possible.            Injuries and system failure during operation possible.            Avoid heavy vibrations. Take safety measures if need be.</p>
---	---

4. It may be necessary to apply corrosion protection adapted to the ambient conditions (e.g. environment with high chloride content). Make sure that the manufacturer's instructions remain legible.

	<p><b>ATTENTION!</b>            Loss of product conformity due to loss of lettering.            Warranty becomes null and void.            Lettering must be legible.</p>
---	---

## Operation, Maintenance and Repair

### Principles

- The valve is maintenance-free.
- As part of the regular system inspection the valve should be checked for corrosion/damage and operability and its proper condition restored if necessary.

	<p><b>WARNING!</b>            Media contact possible, contact with hot/cold surfaces.            Burns, frostbites            Wear personal protective equipment as prescribed by national regulations during maintenance and inspections.</p>
---	--

	<p><b>DANGER!</b>            Danger of valve bursting.            Most serious injuries possible.            The test pressure must not exceed the allowable pressure (PS).            Always observe the safety regulations (e.g. DIN EN 378).</p>
---	---

## Repair

- If the intended valve function can no longer be guaranteed, stop the system, discharge the refrigerant from the system (or section as the case may be) in an environmentally appropriate way and ventilate the system (or section).

	<p><b>DANGER!</b> Refrigerant may escape. Leaking refrigerant may cause most serious injuries. For repairs the system must have the right temperature, free from refrigerant and sufficiently ventilated.</p>
---	---

- Remove the valve from the system and replace it by a new one. Installation/start-up must be carried out as prescribed by the operating instructions. Repeated leakage and strength tests are indispensable.

## Dismantling and Disposal

### Principles

- To dismantle the valve, shut off the system, remove the refrigerant from the system (or system section) in an environmentally friendly manner and sufficiently ventilate the system (or system section).

	<p><b>DANGER!</b> Possible escape of refrigerant. Escaping refrigerant may cause most serious injuries. For repairs the system must have the right temperature, free from refrigerant and sufficiently ventilated</p>
---	---

	<p><b>WARNING!</b> Media contact possible, contact with hot/cold surfaces. Burns, frostbites Wear personal protective equipment as prescribed by national regulations during maintenance and inspections.</p>
---	---

- The valve and its components can be recycled:

Valve body:	metal scrap
Copper pipe:	copper scrap
Internal parts of valve:	stainless steel / aluminium scrap
Protective spindle cap:	plastics (PE)





**Armaturenwerk Altenburg GmbH**

Am Weißen Berg 30  
04600 Altenburg

Telefon           +49 (0) 3447-893-0  
Telefax           +49 (0) 3447-811-10

Internet:         <http://www.awa-armaturenwerk.de>  
E-Mail:            [info@awa-armaturenwerk.de](mailto:info@awa-armaturenwerk.de)

Subject to change as of: 06.2018  
Document 90000721 Revision 00