



Operating Instructions
in compliance with
Pressure Equipment Directive 2014/68/EU

AWA Cast Compressor Valve



Please read these operating instructions carefully to ensure a safe operation and keep the same for further use.



Contents

Safety.....	4
Authorized personnel.....	4
Residual dangers.....	4
Symbols used for safety information	4
General safety information	5
Other information.....	5
Description of Valve.....	6
Types (possible valve connections)	6
Operating principle	7
Product description.....	7
Identification	8
Technical parameters.....	8
Design Features	9
Transport and Storage.....	9
Mounting.....	10
Principles	10
Mounting preparation.....	10
Connecting pipe and compressor.....	10
Commissioning	12
Principles	12
Steps of commissioning.....	12
Operation, Maintenance and Repair	13
Principles	13
Handling the service connections.....	14
Repair	14
Dismantling and Disposal.....	15
Principles	15

Safety

The AWA Cast Compressor Valve, hereinafter referred to as valve, is designed for use in refrigeration/air conditioning systems referred to as systems hereinafter. It may only be put into service if installed into the system unchanged in accordance with these instructions and as a whole is compliance with the statutory provisions.

The valve incorporates state-of-the-art technology and has been built according to the applicable regulations. Great valve has been set upon the user's safety.

These operating instructions are integral part of the contract and shall be kept throughout the entire life of the valve.

Authorized personnel

Only trained and instructed personnel shall be allowed to do any work on the valve and system. As regards the qualification and expertise of the personnel the applicable rules and guidelines shall apply.





Residual dangers

Unavoidable residual hazards may emanate from the valve. Every person working on this device shall therefore carefully read these instructions.

To be observed are for example:

- the generally accepted safety regulations,
- EC directives,
- Norms (e.g. EN 378) and all national provisions.





Symbols used for safety information

	<p>DANGER! Instructions on preventing imminent serious danger to persons. Imminent most serious injuries or death as a possible consequence. Any non-observance may lead to an immediate failure of the valve.</p>
	<p>WARNING! Instructions on preventing potential serious danger to persons. Avoidable serious to very serious injuries or death as a possible consequence. Any non-observance can cause the valve to fail.</p>
	<p>CAUTION! Instructions on preventing a minor danger to persons. Minor, reversible injuries cannot be excluded. Any non-observance may lead to a medium-term failure of the valve.</p>
	<p>ATTENTION! Instructions on preventing potential damage to equipment. Minor, reversible injuries cannot be excluded. Any non-observance may lead to a medium-term failure of the valve.</p>

General safety information

These operating instructions are based on the safety requirements of DIN EN 378-2 and DIN EN 12284.

Instructions to prevent dangers in all cycles of service life:

	DANGER! Risk of bursting if operated beyond the technical parameters. Most serious injuries and immediate system failure possible. Observe the technical parameters.
	WARNING! Damage due to improper handling. Serious injuries and system failure possible. Never use the valve as transport, lifting or lashing point.
	WARNING! Any non-observance of the instructions may cause the valve to fail. Avoidable serious to very serious injuries or death possible. Installation, operation and maintenance by authorized trained personnel only.
	WARNING! Risk of service fluid to be released. Depending on the kind of service fluid serious to very serious injuries or death possible. Wear personal protective equipment (e.g. respirators, gloves).
	CAUTION! Very cold or very hot surface temperatures possible. Frostbites/burns possible. Wear personal protective equipment (e.g. respirators, gloves).

Other information

The information contained herein represents to the best of our belief our knowledge at the time when these instructions were prepared. It shall serve as code of practice to ensure a safe handling of the valve in transport, storage, installation, commissioning, maintenance and dismantling/disposal. A final decision as to whether the valve suits the purpose is to be taken by the user. This information shall not be deemed a warranty of quality.

Any modification of the valve and operation under other than the prescribed parameters shall not be allowed and will result in the loss of the conformity declaration and all liability claims.

Description of Valve

Types (possible valve connections)

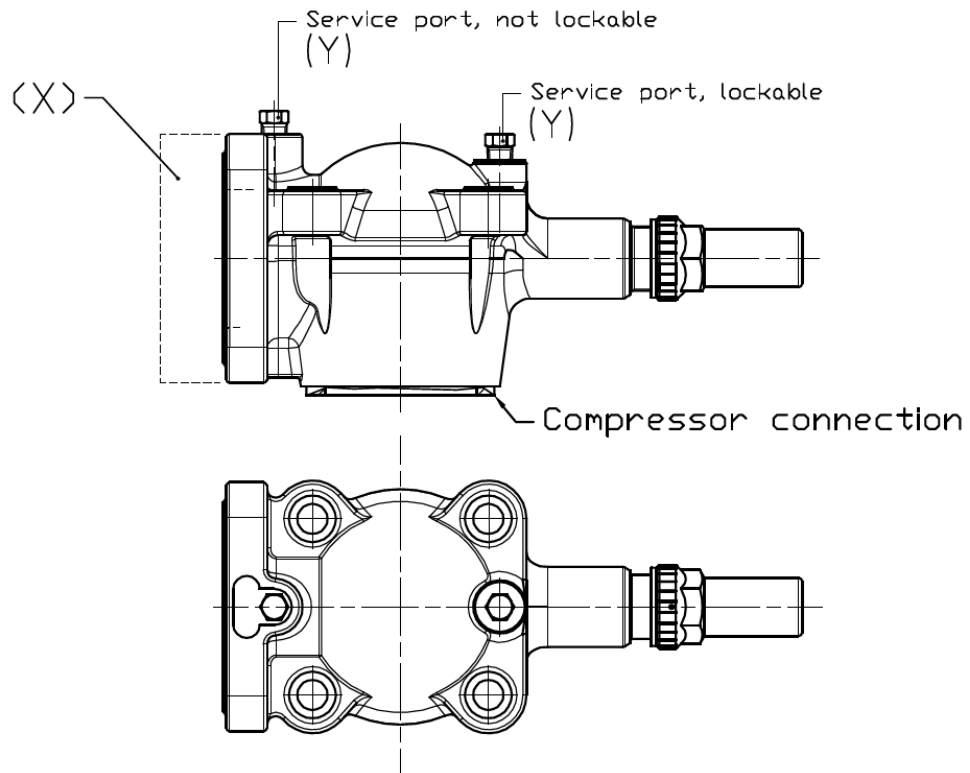

Connection for service port (Y)

C
Plug



D
Service port
Flare connection
SAE 1/4"



E
Service port
Pipe fitting
CEL $\phi 6$



Connection for system (X)

A
Flange with
brazing bush

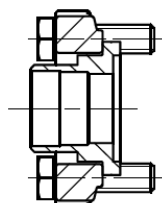

B
Flange with
welding bush

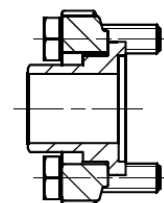

Installation dimensions can be gathered from the AWA product catalogue and technical documents respectively.

The connecting options A through E are explained in more detail under "Design features".

Operating principle

spindle on valve seat
closed

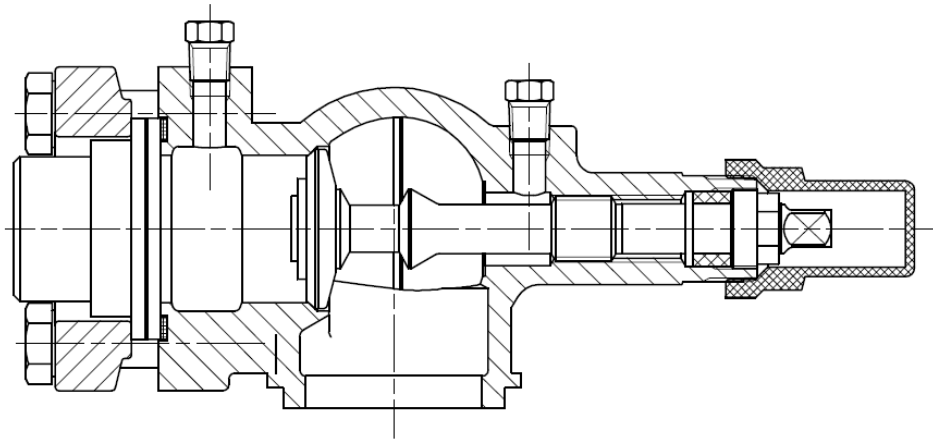

spindle on back seat
opened

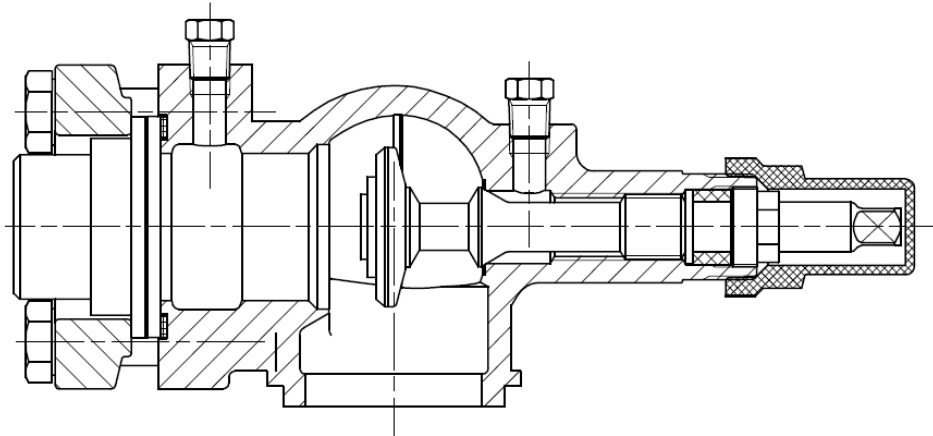

flow direction

Product description

The AWA Cast Compressor Valve is an angle shut-off valve for refrigeration or air conditioning systems and is designed for direct attachment to the compressor. For operation the spindle has to be fully open or fully closed. According to DIN EN 378-2 the valve can only be actuated by use of a tool. When supplied the valve spindle is closed.

Any flow direction can be chosen.

The valve is in compliance with DIN EN 12284:2003 and Pressure Equipment Directive 2014/68/EU.



Identification

The valve is marked in accordance with DIN EN 12284:

Cast-in on valve housing:

- Manufacturer's logo
- Maximum allowable pressure / nominal size
- Housing material
- UL mark
- CE mark for valves of category I
- CE mark with ID number of notified body for valves of category II

Inscribed on cast housing:

- Date of manufacture
- Special design (NH₃ or propane)

Technical parameters

Pressure/Temperature allocation:

PS 35bar at TS -10 ... 140°C
PS 26bar at TS -40 ... -10°C

Service fluids:

Refrigerant as per EN 378-1 (2016) - PED fluid group 2 and relevant refrigeration compressor oils according to DIN 51503-1.

On request other refrigerants can be permitted (e.g. R290, R717). It is explicitly described in the technical documentation.

Leakage test:

according to DIN 8964-3 (<4.1 g/a R-134a at 10bar)

Strength test:

according to DIN EN 12284 at 1.43-fold PS

Cleanliness of interior:

according to DIN 8964-1

Classification pursuant to Pressure Equipment Directive (PED 2014/68/EU):

Nominal size	DN32	DN40	DN50	DN80	DN100
Standard design for refrigerant of PED fluid group 2	Sep	Category I			
Special design for refrigerant of PED fluid group 1	Category II				

Approval according to UL 207

The valve has been approved according to UL 207 for the American and Canadian market.

Design Features

- The material of the valve components and the manufacturing method are selected in conformity with the EN12284:2003 and Pressure Equipment Directive 2014/68/EU thus guaranteeing the reliability for the operating range indicated.
- The system connection comes as detachable soldered or welded connection. The compressor connection is specifically adapted to the connecting conditions of the different manufacturers.
- On request the valve can be supplied for use of refrigerant of the DGRL fluid group 1 (e.g. propane, ammonium).
- For actuation the valve spindle is provided with a square and has a metal back seat function. The back seat is only effective when the valve is completely open. Sealing between the spindle and housing is rendered by a graphite packing and gland seal.
- As standard the valve is supplied with a highly leak-proof protective spindle cap with pressure relief hole.
- Types of connection

Connection "A" – Detachable brazed capillary connection to render a brazed joint with copper pipes according to DIN EN 12735-1:2010 for Ø12 to Ø108mm. Inch-type pipes 7/8" up to 4 1/8" available on request. The flange connection is a tongue-and-groove system with fibre gasket.

Connection "B"– Detachable welded connection for use of steel tube dimensions according to DIN EN 10220:2003-03 for outside diameters of 31.8 to 114.3mm. The flange connection is a tongue-and-groove system with fibre gasket.

Connection "C" Detachable service connection with sealing plugs that is available as non-lockable and/or lockable type the valve fully open by back seat of the spindle.

Connection "D" Detachable service connection SAEM ¼" that is available as non-lockable and/or lockable type with the valve fully open by back seat of the spindle.

Connection "E" Detachable service connection for cutting-ring connection CEL dia. 6 available as non-lockable and/or lockable type with the valve fully open by back seat of the spindle.

- The valve comes with temporary corrosion protection (manganese phosphating, zinc coat, prime coat). This kind of coating ensures protection against corrosion until installation if handled and stored in dry condition.
- The service-friendly design makes it possible to purchase spare parts separately (e.g. protective spindle cap, gaskets, flange, bushing).

Transport and Storage

Transport the valve by closed means of transport in the original packing protected against weather influences and store it in dry areas.

Mounting

Principles

- The valve shall be arranged in the system so that it can be properly operated and maintained.

	<p>DANGER! Damage of valve possible. Serious injuries and system failure possible during operation. Valve to be installed without additional loads (forces, vibrations). Cast manual shut-off valves must not be used as fixing points of pipes.</p>
---	--

- The removal space for spindle operation and the removal of the protective spindle cap shall be about 100mm.
- A safe operation of the spindle (opening and shutting off) at the required torques must be possible.
- Only authorized personnel shall be allowed to mount the valve.

	<p>DANGER! Any non-observance of these instructions may cause the valve/system to fail. Most serious injuries and death possible. Mounting and operation by personnel trained in refrigeration systems only.</p>
---	--

- No modifications of the valve permitted. If modifications become necessary, they have to be agreed with the manufacturer prior to mounting.

	<p>WARNING! Product features may change. Avoidable serious to very serious injuries or death possible. Any modification of the valve has to be agreed with manufacturer in advance.</p>
---	---

Mounting preparation

- When supplied the valve is closed and may come with additional protective means for transport. To avoid corrosion inside the valve and contamination, such protective means should be removed shortly before mounting.

	<p>ATTENTION! Possible damage of interior components. Malfunction due to oxidation/contamination of internal components. Remove the transport protection shortly before mounting.</p>
---	---

- Connections A & B only: Remove connecting parts (flange screws, flange, bushing, gasket). Keep these components safe until use.

Connecting pipe and compressor

1. The pipe must be of a dimension that fits the system. If not, use adapters.
2. Prepare the system connections so (bare metal and free from grease) that a high-quality joint is possible.

3. Scavenge the relevant pipe sections with shielding gas during brazing and welding. Then, cool down the system connection in the air.

	WARNING!
	Damage of valve (e.g. crack formation) due to rapid cooling possible. Serious injuries and system failure during operation possible. Allow the joint to cool down in the air.

	ATTENTION!
	Damage of internal components possible. Malfunction due to oxidation of internal components. Scavenge with shielding gas while doing the joining.

4. Clean the pipe connections made. Flux material residues are very corrosive and may cause long-term damages.

	CAUTION!
	Risk of increased corrosion and component damage. Serious injuries and system failure possible during operation. Properly clean the joint after joining.

5. The compressor connection must be in line with the data of the compressor manufacturer. Mount the valve at the compressor using the mounting material prescribed by the compressor manufacture. Make sure there is no mechanical constraint. Tighten the nuts/screws crosswise in minimum 2 steps applying the given torques (item 9).

	WARNING!
	Any excessive torque or non-observance of the mounting order may cause failures. Serious injuries and system failures possible during operation. Observe the torques.

6. Connections A & B only: Attach the connecting parts incl. pipe to the valve. Make sure there is no mechanical constraint. Tighten the connecting flanges in a criss-cross manner in min. 2 steps applying the torques indicated (see item 7).

	WARNING!
	Any excessive torque or non-observance of the mounting order may cause failures. Serious injuries and system failures possible during operation. Observe the torques.

7. Connections C, D and E: As far as needed the service connections shall be used for the installation of additional system components.

	WARNING!
	Potential malfunction of safety devices. Serious injuries and system failure possible in subsequent operation. Never connect safety devices to the lockable service connection.

8. Depending on the intended operating state open or close the spindle completely. Loosen the gland seal by ¼ turn before you move the spindle. Then, tighten the gland seal and put on the protective spindle cap. If there is only one connection at the valve shut the other connection with the dust cap until further use.

9. Depending on the nominal diameter the following torques apply (Nm):

Nominal diameter	Spindle square end	Spindle closed	Spindle open	Protective spindle cap	Gland
DN 32	3/8"	30 +5	17 +5	14 +2	17 +5
DN 40	3/8"	40 +10	30 +10	20 +5	17 +5
DN 50	3/8"	60 +10	50 +10	20 +5	17 +5
	1/2"	60 +10	50 +10	30 +5	50 +10
DN 80	1/2"	80 +10	50 +10	30 +5	50 +10
DN 100	1/2"	100 +10	50 +10	30 +5	50 +10
	3/4"	100 +10	70 +10	30 +5	80 +10

The following torques apply to the bolts of the system/compressor connection:

Thread	Torque in Nm
M8	25 ±5
M10	50 ±5
M12 or 1/2" UNC	85 ±5
M16 or 5/8" UNC	150 ±10
M18, M20 or 3/4" UNC	200 ±10

The following torques apply to the service connection (Y):

Thread	Torque in Nm
1/8 -27 NPTF	10 +10
1/4 -18 NPTF	20 +20

The use of a sealant is permitted.

Commissioning

Principles

- The valve has already been tested for leakage and strength by the manufacturer.
- The valve and the system into which it is installed, may only be commissioned if they have been checked, with due regard to the intended mode of operation, for proper condition as to assembly, installation, set-up conditions and safe functioning.
- After mounting and initial start-up according to DIN EN 378-2 check again for leakage and strength and an effective corrosion protection.

Steps of commissioning

1. Check the system for resistance to pressure by suitable means (e.g. helium, dry nitrogen).

	DANGER!
	Danger of bursting.
	Most serious injuries possible.
	The test pressure must not exceed the maximum allowable pressure (PS). Strictly observe the safety information (e.g. DIN EN 378).

- It is absolutely necessary to apply an anticorrosive coating that suits the operating conditions because the valve comes with a temporary corrosion protection only. Make sure that the fabrication data remain legible.

	<p>CAUTION! Delayed failure due to corrosion possible. Serious injuries and failure of system during operation possible. Apply a suitable anticorrosive coat.</p>
---	---

- Evacuating and filling the system with refrigerant.

	<p>DANGER! Danger of bursting if operated beyond the technical parameters. Most serious injuries possible. Observe the technical parameters of the valve. Make sure the system is not filled with an excessive amount of refrigerant.</p>
---	--

- Depending on the intended operating condition either completely open or close the spindle. (loosen / tighten the gland). Then, put on the protective cap and tighten it applying the prescribed torque (see chapter "Mounting").

	<p>WARNING! Any torque beyond the limits may lead to failure. Serious injuries and system failure during operation possible. Observe the torques.</p>
---	---

- Upon initial commissioning check the pipes for any abnormal vibration and record the operating data.

	<p>CAUTION! Cracks of the piping and the valve due to dynamic loads possible. Injuries and system failure during operation possible. Avoid heavy vibrations. Take safety measures if need be.</p>
---	---

Operation, Maintenance and Repair

Principles

- The valve is maintenance-free.
- As part of the regular system inspection it should be checked for corrosion/damage and operability and its proper condition restored if necessary.

	<p>WARNING! Media contact possible, contact with hot/cold surfaces. Burns, frostbites Wear personal protective equipment as prescribed by national regulations during maintenance and inspections.</p>
---	--

- If the valve spindle has to be operated for system maintenance, carefully remove the protective spindle cap. If no pressure compensation can be effected, put the protective spindle cap in place again and tighten it. If so, it indicates a malfunction of the valve and the system has to be stopped without delay.

	<p>WARNING! The protective spindle cap is pressure-proof and may be pressurized. Serious injuries possible. Slowly remove the protective cap of the spindle. Allow any service fluid escape from inside the cap if necessary.</p>
---	---

Then, put the spindle in the correct position applying the necessary torques (see chapter Mounting) (loosen/tighten the gland). A leak test is absolutely necessary. Upon completion of work put the protective spindle cap in place again.

DANGER!

Danger of valve bursting.
Most serious injuries possible.
The test pressure must not exceed the allowable pressure (PS).
Always observe the safety regulations (e.g. DIN EN 378).

Handling the service connections

Depending on the configuration the valve may have a lockable and/or **non-lockable** service connection:

1.) Lockable service connection

When the spindle is opened completely the back seat disconnects the connection from the circuit. It is thus possible to connect temporary service equipment. For technical reason a slight amount of operating fluid at a certain pressure remains in the hollow space from the back seat to the connection that escapes when the connection is opened. If no pressure compensation can be achieved within a short period of time, shut the connection immediately.

CAUTION!

Escape of slight amounts of operating fluid possible.
Minor, reversible injury cannot be excluded.
Carefully open the connection. Wear personal protection equipment.

2.) Non-lockable service connection

Whatever the spindle position, this connection is **not** disconnected from the circuit. Use is therefore exclusively intended for permanently connected safety devices/pressure gauges.

DANGER!

The non-lockable service connection pressurized permanently.
Serious injury caused by loose parts and escape of greater amounts of operating fluid possible.
The system should be depressurized for any work on the non-lockable service connection.

Repair

- If the valve needs repair, shut down the system, drain the refrigerant from the system (or system section) in an environmentally friendly manner and ventilate the system.

DANGER!

Refrigerant may escape.
Leaking refrigerant may cause most serious injuries.
For repairs the system must have the right temperature, free from refrigerant and sufficiently ventilated.

- For repairs use no other than original spare parts (AWA valve, gasket, flange, bush). The valve cannot be repaired, it has to be replaced upon failure. For mounting/start-up follow these operating instructions. It is indispensable to do a leakage and strength test once again. AWA assumes no warranty for tightness after repairs.

	WARNING!
	Valve damage due to defective spare parts/mounting. Avoidable serious injuries and system failure possible. Use no other than original spare parts for repairs.

Dismantling and Disposal

Principles

- To dismantle the valve, shut off the system, remove the refrigerant from the system (or system section) in an environmentally friendly manner and sufficiently ventilate the system (or system section).

	DANGER!
	Possible escape of refrigerant. Escaping refrigerant may cause most serious injuries. For repairs the system must have the right temperature, free from refrigerant and sufficiently ventilated

	WARNING!
	Media contact possible, contact with hot/cold surfaces. Burns, frostbites Wear personal protective equipment as prescribed by national regulations during maintenance and inspections.

- The valve and its components can be recycled:

Valve body:	cast iron scrap
Flanges	cast iron scrap
Protective spindle cap:	plastics
Dust caps:	plastics



Armaturenwerk Altenburg GmbH

Am Weißen Berg 30
D-04600 Altenburg
Germany

Telefon +49 (0) 3447-893-0
Telefax +49 (0) 3447-811-10

Internet: <http://www.awa-armaturenwerk.de>
E-Mail: info@awa-armaturenwerk.de

Subject to change as of: 04.2017
Document 90000708 Revision 02