

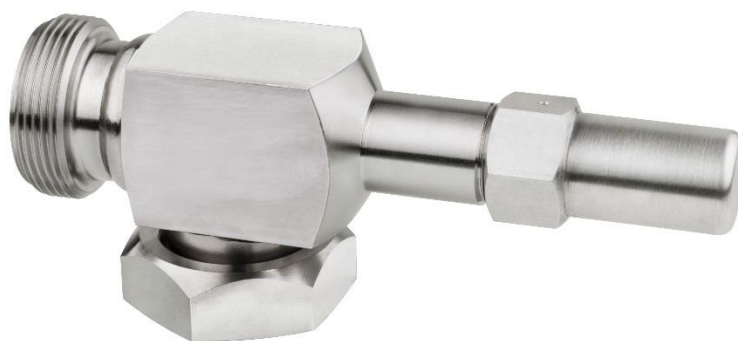

Operating Instructions
in compliance with
Pressure Equipment Directive 2014/68/EU
and
Pressure Equipment (Safety) Regulation 2016,
UK Statutory Instrument 2016 No. 1105

Steel Valves
Stainless Steel Valves



Please read these operating instructions carefully to ensure a safe operation and keep the same for further use.



Contents

Safety.....	3
Authorized personnel.....	3
Residual dangers.....	3
Symbols used for safety information	Fehler! Textmarke nicht definiert.
General safety information	Fehler! Textmarke nicht definiert.
Other information.....	Fehler! Textmarke nicht definiert.
Description of Valve.....	5
Types (possible valve combinations)	5
Operating principle	6
Product description.....	7
Marking.....	Fehler! Textmarke nicht definiert.
Technical parameters.....	7
Design Features	8
Transport and Storage.....	9
Mounting.....	10
Principles	10
Mounting preparation.....	10
Connecting pipe / system	11
Commissioning	14
Principles	14
Steps of commissioning.....	14
Operation, Maintenance and Repair	15
Principles	15
Repair	15
Dismantling and Disposal	16
Principles	16

Safety

The Steel Valve or Stainless Steel Valve, hereinafter referred to as valve, is designed for use in refrigeration/air conditioning systems referred to as systems hereinafter. It may only be put into service if installed into the system unchanged in accordance with these instructions and as a whole is compliance with the statutory provisions.

The valve incorporates state-of-the-art technology and has been built according to the applicable regulations. Great valve has been set upon the user's safety.

These operating instructions are integral part of the contract and shall be kept throughout the entire life of the valve.

Authorized personnel

Only trained and instructed personnel shall be allowed to do any work on the valve and system. As regards the qualification and expertise of the personnel the applicable rules and guidelines shall apply.





Residual dangers

Unavoidable residual dangers may emanate from the valve. Every person working on this device shall therefore carefully read these instructions.

To be observed are for example:

- the generally accepted safety regulations,
- EC directives,
- Norms (e.g. EN 378) and all national provisions.





Symbols used for safety information

	DANGER! Instructions on preventing imminent serious danger to persons. Imminent most serious injuries or death as a possible consequence. Any non-observance may lead to an immediate failure of the valve.
	WARNING! Instructions on preventing potential serious hazard to persons. Avoidable serious to very serious injuries or death as a possible consequence. Any non-observance can cause the valve to fail.
	CAUTION! Instructions on preventing a minor hazard to persons. Minor, reversible injuries cannot be excluded. Any non-observance may lead to a medium-term failure of the valve.
	ATTENTION! Instructions on preventing potential hazard to equipment. Minor, reversible injuries cannot be excluded. Any non-observance may lead to a medium-term failure of the valve.

General safety information

These operating instructions are based on the safety requirements of EN 378-2 and EN 12284.

Instructions to prevent hazards in all cycles of service life:

	DANGER! Risk of bursting if operated beyond the technical parameters. Most serious injuries and immediate system failure possible. Observe the technical parameters.
	WARNING! Damage due to improper handling. Serious injuries and system failure possible. Never use the valve as transport, lifting or lashing point.
	WARNING! Any non-observance of the instructions may cause the valve to fail. Avoidable serious to very serious injuries or death possible. Installation, operation and maintenance by authorized personnel only.
	WARNING! Risk of service fluid to be released. Depending on the kind of service fluid serious to very serious injuries or death possible as a consequence. Wear personal protective equipment (e.g. respirators, gloves).
	CAUTION! Very cold or very hot surface temperatures possible. Frostbites/burns possible. Wear personal protective equipment (e.g. gloves, protective clothes).

Other information

The information contained herein represents to the best of our belief our knowledge at the time when these instructions were prepared. It shall serve as code of practice to ensure a safe handling of the valve in transport, storage, installation, commissioning, maintenance and dismantling/disposal. A final decision as to whether the valve suits the purpose is to be taken by the user. This information shall not be deemed a warranty of quality.

Any modification of the valve and operation under other than the prescribed parameters shall not be allowed and will result in the loss of the conformity declaration and all liability claims.

Description of Valve

Types (possible valve combinations)

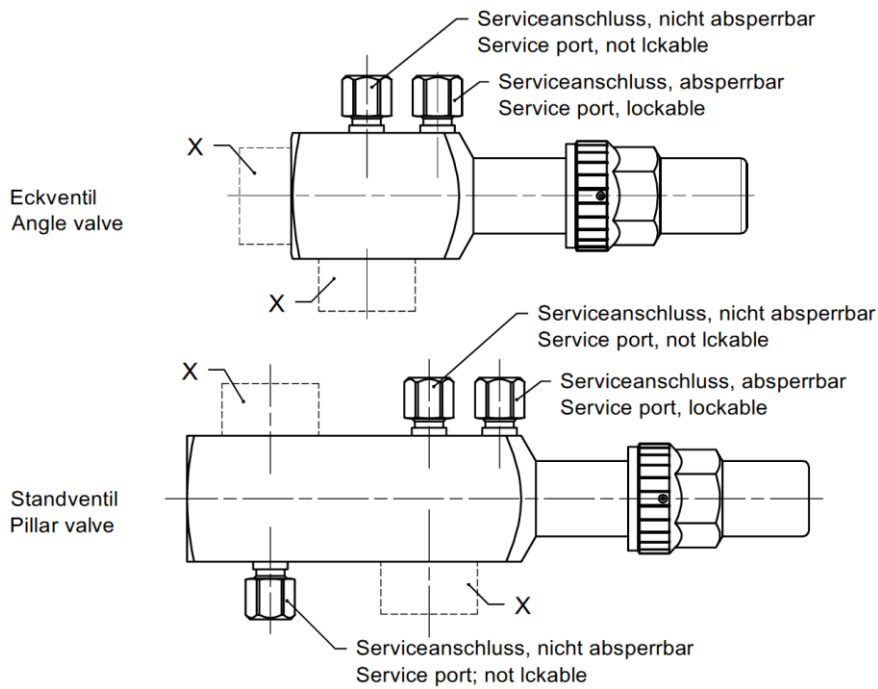

Varianten für Anlagenanschluss X

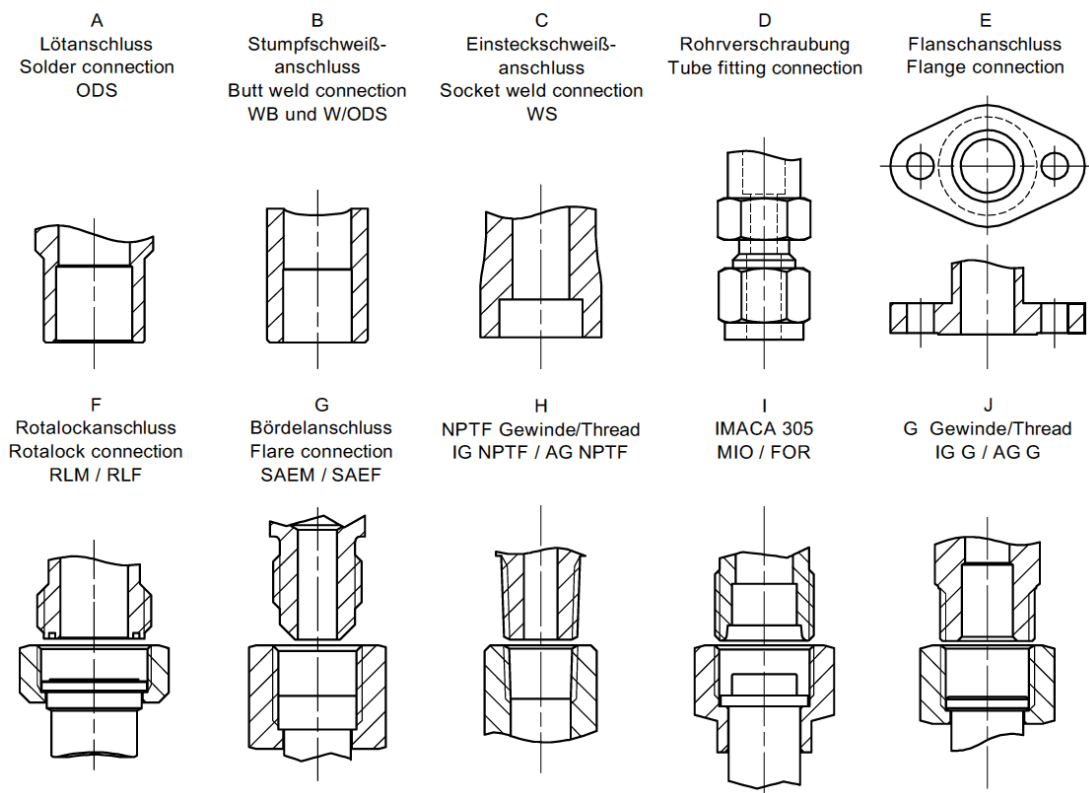

Installation dimensions can be gathered from the AWA product catalogue and technical documents respectively. The connecting options A through J are explained in more detail in "Design features".

Operating principle

Spindel auf Ventilsitz geschlossen
 Spindle position on valve seat closed

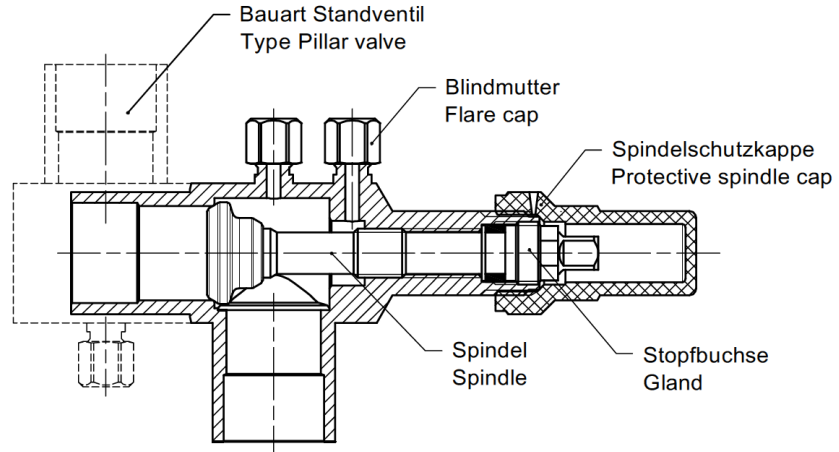

Spindel geöffnet
 Spindle position open

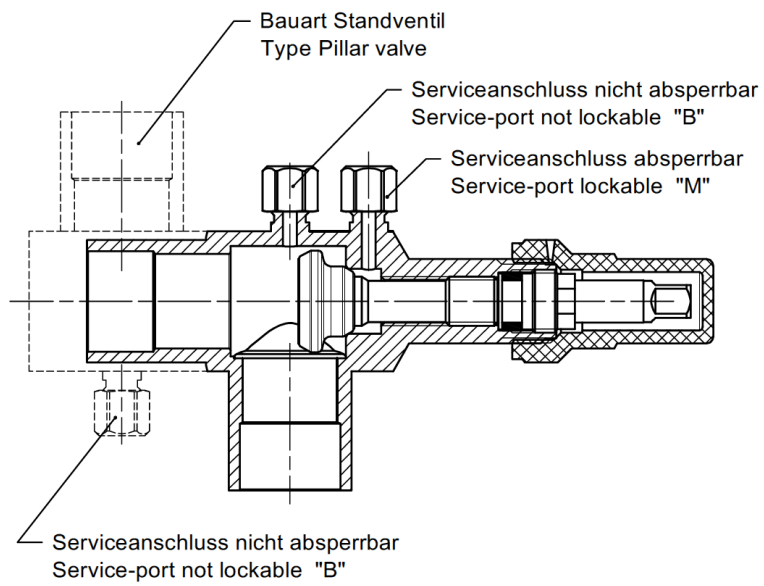

Benennung Serviceanschlüsse
 Designation Service connections

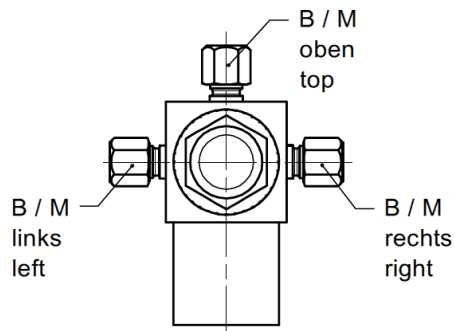



Product description

The valve is intended for refrigeration or air conditioning systems. It is a manual shut-off valve. Depending on the design and connection variant, the valve can be used as a system valve or for direct attachment to compressors.

Any flow direction can be chosen.

The valve is in compliance with EN 12284, the Pressure Equipment Directive 2014/68/EU and the Pressure Equipment (Safety) Regulation 2016, UK Statutory Instrument 2016 No. 1105.

Identification

The valve is marked in accordance with EN 12284 by lettering on the valve body:

- Manufacturer's logo
- Type type and size (e.g. S30, E30, E30NH3)
- AWA parts number
- Coded year of manufacture
- Maximum allowable pressure PS in bar
- Nominal size DN in mm
- Housing material
- UL-mark
- **CE / UKCA** mark and identification number of the notified body (if applicable)

Technical parameters

Allowable pressure / temperature / service fluids:

Maximum allowable pressure PS: As indicated in the technical documents.

Allowable temperature TS: As indicated in the technical documents.

Permitted service fluids: Refrigerants acc. to EN 378-1 (2016):
As indicated in the technical documents.

Depending on the valve design, the following basic suitability for service fluids results:

	Valve type "S" ¹ / "6kt19"	Valve type "E" ²	Valve type "E__NH3" ³
PED fluid group 2	yes	yes	yes
Safety Group A1 to A3 and B1 (PED Fluid Group 1 and 2)	on request	on request	on request
Safety Group A1 to A2, B1 and B2L (PED Fluid Group 1 and 2)	no	no	yes

Leakage test:

according to DIN 8964-3 (<4.1 g/a R-134a at 10bar)

Strength test:

according to EN 12284 at 1.43-fold PS

Cleanliness of interior:

according to DIN 8964-1

¹ Valid for: S19, S22, S30, S30F, S36, S40, S40CO2, S50, S50CO2, S55CO2

² Valid for: E22, E30, E40, E50

³ Valid for: E22NH3, E30NH3, E40NH3, E50NH3



Classification pursuant to Pressure Equipment Directive 2014/68/EU and PE(S)R 2016:

See information in the technical documentation.

For products of category I components are provided with **CE** and UKCA mark.

For products of category II components are provided with **CE** 0090 and UKCA 1521 mark with indication of the notified body.

Approval under UL 207

The valve types "S", "E" and "E__NH3" are UL 207 approved for the US and Canadian market.

Design Features

- The material of the valve components and the manufacturing method are selected in conformity with the EN 12284, the Pressure Equipment Directive 2014/68/EU and the Pressure Equipment (Safety) Regulation 2016 thus guaranteeing the reliability for the operating range indicated.
- The valves are made of one of the material given below:
 - The **"S" and "6kt19" type valves** are made of steel components connected with each other by high-strength and high-density copper brazing and subsequent electroplated coating. The latter provides for corrosion protection until installation if transported and stored in dry condition.
 - The **"E" type valves** are made of stainless steel components 1.4301 which are connected permanently by copper brazing and/or welding.
 - The **"E__NH3" type valves** are made of stainless steel components and permanently connected with each other by welding.
- The use of temperature-resistant materials, connecting elements and jointing methods obviate the need of dismantling when the valve is installed (brazing and welding) in the system.
- The valve spindle is designed with a square for actuation and has a metal back sealing function. The latter is only operative when the valve is fully open. The sealing between spindle and housing is by a graphite packing and adjustable gland seal.
- The valve comes as standard with a plastic high-density protective spindle cap. Depending on the admissible operating parameters the valve has a protective spindle cap of aluminium. Both types of protective spindle cap are provided with a relief hole.
- Types of connection:

Because of the design principle, the inlets and outlets of the valve can have different connections as well as positions or distances to each other.

Connection "A" – Brazed capillary connection to render a brazed joint with copper pipes according to EN 12735-1 for dia. 6 to 54mm and relevant inch dimensions. Designed as connection for insertion of a copper pipe (ODS) or insertion of a brazed fitting (ODM).

Abbreviated designation: (W /) ODS xx or ODM xx (xx stands for relevant size in mm or inch).

Connection "B & C" – Welded connection for use of pipes according to EN 10220 and relevant inch-type dimensions. Designed as butt-welded connection (W or WB) or plug-in welded connection (WS).

Abbreviated designation: WB xx, W xx and WS xx (xx stands for relevant size in mm or inch).

Connection "D" – Detachable connection for compression joints and O-ring screw connections according to DIN 2353, EN ISO 8434 or other.

Connection "E" – Detachable flange connection designed as 2-hole oval flange (hole distance 35 to 70mm) or 4-hole rectangular flange (hole distance 40 to 85mm) for use of a metal bead or fibre gasket.

Abbreviated designation: F xx (xx stands for relevant size in mm or inch)

Connection "F" – Detachable threaded connection according to Rotalock principle using a PTFE seal ring designed as connection with male (RLM) or female (RLF) thread. Optimal results of this screw joint are achieved when no other than AWA components are used.

Abbreviated designation: RLM xx and RLF xx resp. (xx stands for relevant size in mm or inch)

Connection "G" – Detachable threaded connection with 90° sealing cone according to flare connection principle (SAE J516, DIN 3866), designed as connection with male (SAEM) or female threads (SAEF) to connect a copper pipe or mount the valve on a mating piece.

Abbreviated designation: SAEM xx and SAEF xx resp. (xx stands for relevant SAE size)

Connection "H" – Detachable threaded connection with NPTF thread acc. to ANSI B1.20.3, designed as connection with male (AG NPTF) or female thread (IG NPTF).

Abbreviated designation: AG NPTF xx and IG NPTF xx resp. (xx stands for relevant size in inch).

Connection "I" – Detachable threaded connection with cylindrical inch-type thread according to IMACA Standard 305, designed as connection with male (MIO) or female thread (FOR) for use of an O-ring as sealing element.

Abbreviated designation: MIO xx and FOR xx resp. (xx stands for the relevant size)

Connection "J" – Detachable threaded connection with cylindrical pipe thread acc. ISO 228, designed as connection with male (AG G) or female (IG G) thread for use of a metal gasket as sealing element.

Abbreviated designation: AG G xx and IG G xx resp. (xx stands for the relevant size)

- Other connections can be agreed separately and are described in the relevant technical documents of the product. Suitable adapters for other connections are available in the AWA product range.
- Design, function and arrangement of service connections:

Depending on the configuration, the valve can have lockable (designation "M") and/or non-lockable (designation "B") service connections for the installation of further system components (see chapter "Operating principle").

The arrangement of the service connections is shown in the chapter "Operating principle".

In the standard version, the connection is designed as a detachable threaded fitting with a 90° sealing cone in the SAEM ¼" size and closed with a metal-sealing blind nut. Other versions, such as ODS, NPTF, CEL etc. can be supplied by agreement.

Transport and Storage

Transport the valve by closed means of transport in the original packing protected against weather influences, and store it in a dry place.

Mounting

Principles

- The valve shall be arranged in the system so that it can be properly operated and maintained.

	DANGER!
	Damage of valve possible.
	Serious injuries and system failure possible during operation.
	Valve to be installed without additional loads (forces, vibrations). Never use the valve as fixing points of pipes.

- The removal space for spindle actuation and the removal of the protective spindle cap shall be about 100 mm. Also observe the removal space for service connections.
- A safe operation of the spindle (opening and shutting off) with the required tightening torques (torque spanner) must be possible.
- The flow can pass the valve in both directions.
- The valve should be installed with the valve spindle in a horizontal position or with the valve spindle vertical upwards.
- The valve must be integrated into the pipe on both sides. An outlet side open to the outside is not permitted!
- Only authorized personnel shall be allowed to mount the valve.

	DANGER!
	Any non-observance of these instructions may cause the valve/system to fail.
	Most serious injuries and death possible.
	Mounting and operation by personnel trained in refrigeration systems only.

- No modifications of the valve are permitted. If modifications become necessary, they have to be agreed with the manufacturer beforehand.

	WARNING!
	Product features may change.
	Avoidable serious to very serious injuries or death possible.
	Any modification of the valve has to be agreed with manufacturer in advance.

Mounting preparation

- Unless specified otherwise in the technical documentation the supplied valve is closed and may come with additional protective means for transport. To avoid corrosion inside the valve and contamination, such protective means should be removed shortly before mounting.

	ATTENTION!
	Possible damage of interior components.
	Malfunction due to oxidation/contamination of internal components.
	Remove the transport protection shortly before mounting.

- For connections A through C only: The spindle must be in centre position. Before moving the spindle, loosen the gland seal by ¼ turn. Do not put on again the spindle cap and keep it until mounting is complete.

	ATTENTION!
	Possible damage of interior components.
	Malfunction of the valve thermal overload.
	Spindle must be in centre position for thermal joining methods.

Connecting pipe / system

- Make the connection of the inlet and the outlets in compliance with the following connection-specific principles:

The pipe must be of a dimension that fits the valve. If not, use adapters.

Make sure there is no mechanical restraint.

- **For soldered/welded connections (connections A through C):**

Prepare the system connections so (bare metal and grease-free) that a high-quality joint can be achieved.

Scavenge the relevant pipe sections with shielding gas during soldering / welding. A cooling of the valve body is recommended.

Then, cool down the system connection in the air.

Clean the pipe connection made. Flux material residues from the soldering process are very corrosive and may cause long-term damage.

For stainless steel valves observe the general rules to maintain the material properties (e.g. cleaning, passivation, tool selection).



WARNING!

Damage of valve due to excessive heating possible.
 Serious injuries and system failure possible during operation.
 Direct the heat source away from adapter (component temperature max. 850°C)!



WARNING!

Damage of valve (e.g. cracking) due to rapid cooling possible.
 Serious injuries and system failure possible during operation.
 Allow joint to cool down in the air.



CAUTION!

Risk of increased corrosion and component damage.
 Serious injuries and system failure possible during operation.
 Properly clean the joint after joining.



ATTENTION!

Possible damage of interior components.
 Malfunction due to oxidation of internal components.
 Scavenge with shielding gas while joining.

- **For screwed connections (connection D through J):**

Make sure that the connections are in conformity in terms of type and dimension and the sealing elements that may be necessary are used.

If available, use the wrench flats directly arranged at the connection to apply the necessary torques. The torques of the relevant screw connections have to be strictly observed.

Especially when it comes to stainless steel connections it is essential to observe the general technical rules to avoid fretting (use release agents).



WARNING!

Excessive torques or non-observance of the mounting order may cause failures delayed in time.
 Serious injuries and system failure possible during operation.
 Observe the torques and mounting order.

- For connection D only: Rendering screwed pipe union

The assembly of the union nut and the cutting or clamping ring on the pipe as well as the assembly of the pipe on the valve must be carried out according to the instructions by the component manufacturer. For this purpose, the tightening torques or a description of the assembly procedure are listed in an extended technical documentation or in a separate supplement.

- For connection E only: Rendering flange connections

Make sure that the compressor connection is in conformity in terms of type and dimensions and that the required sealing elements are used. Mount the valve on the compressor using the mounting material specified by the compressor manufacturer.

Initially screw the nuts/bolts hand-tight. Then tighten the nuts/bolts crosswise in at least 2 stages to the specified tightening torque.

Thread	Tightening torque (in Nm) at strength class 8.8
M8	25 ±5
M10	50 ±5
M12	100 ±10

- For connection F only: Rendering a Rotalock connection

The PTFE sealing ring matching the screw connection must be inserted into the groove of the adapter with external thread. Afterwards, the screw connection component with internal thread is first screwed hand-tight. Then tighten the Rotalock connection with the specified tightening torque.

Rotalock size	Thread	Tightening torque (in Nm)
RL ¾"	¾-16 UNF	30 +10
RL 1"	1-14 UNS	60 +10
RL 1 ¼"	1 ¼-12 UNF	100 +10
RL 1 ½"	1 ½-12 UN	125 +10
RL 1 ¾"	1 ¾-12 UN	150 +10
RL 2	2-12 UN	160 +10
RL 2 ¼"	2 ¼-12 UN	170 +10

- For connection G only: Rendering the flared coupling

The screw connection is to be tightened with the corresponding counterpart with the following tightening torques.

Pipe diameter EN 12735	Tightening torque (in Nm)
6 mm / ¼"	14 +4
10 mm / ⅜"	33 +9
12 mm / ½"	50 +12
15 /16 mm / ⅝"	63 +14
18 mm / ¾"	90 +20

- For connection H only: Rendering screw joints with NPTF thread

The screw connection is to be tightened with the corresponding counterpart with the following tightening torques.

Thread	Tightening torque (in Nm)
1/8-27 NPTF	10 +3
1/4-18 NPTF	20 +3
3/8-18 NPTF	42 +5
1/2-14 NPTF	60 +10

For the NPTF connection thread sealants may be used.

- For connection I only: Rendering a screw joint according to IMACA 305

Fit the right O-ring onto the cylindrical connecting piece of the female connection component. Initially fasten the cap nut finger-tight. Then, tighten the connection apply the specified torques.

IMACA SIZE	Thread	Tightening torque (in Nm)
4	7/16-20 UNF	7 +3
5	9/16-18 UNF	11 +3
6	5/8-18 UNF	15 +3
8	3/4-16 UNF	20 +5
10	7/8-14 UNF	30 +5
12	1 1/16-14 UNS	40 +5

- For connection J only: Rendering the screw connection with cylindrical pipe thread
Mount the mating piece as specified by the component manufacturer.
- For connection variants or connection sizes not listed here, the tightening torques or a description of the installation procedure are listed in the technical documentation or in a separate supplementary sheet.
- **For service connections:**

Depending on the configuration, the valve can have lockable and/or non-lockable service connections (see chapter "Operating principle").

If necessary, use the service connections for the installation of further system components.

If available, use the wrench flats directly arranged at the connection to apply the necessary torques. The torques of the relevant screw connections have to be strictly observed.



WARNING!

Potential malfunction of safety devices.
Serious injuries and system failure possible in subsequent operation.
Never connect safety devices to the lockable service connection.

The following torques apply to the service connection:

Connection	Torque in Nm
Connection "G" SAE 1/4	Cap nut 5 +5 Flare nut 14 +4
Connection "G" SAE 3/8	Cap nut 15 +5 Flare nut 33 +9
Connection "H" 1/8-27 NPTF	15 +5
Connection "D" CEL6 (24° cone ISO8434)	Blind plug 8 +2Nm

For the NPTF connection thread sealants may be used.

- Depending on the intended condition the spindle must be fully opened or fully closed. Before moving the spindle, loosen the stuffing box by 1/4 turn. After the spindle has been moved tighten the gland with the required torque and screw on the protective spindle cap.
- The following torques apply when it comes to the operation of the spindle and screwing of the protective spindle cap depending on the valve size (in Nm):

Valve size	Spindle position		Gland	Protective spindle cap
	closed	open		
S19 / 6kt19	15 +5	12 +2	12 +5	Plastics 14 +2 Aluminium 40 +10
S22 / E22	20 +5	12 +2	12 +5	
S30 / E30	25 +10	15 +2	15 +5	
S36	40 +10	17 +5	17 +5	
S40 / E40	40 +10	17 +5	17 +5	
S50 / E50	50 +10	17 +5	17 +5	
S55CO2	50 +10	17 +5	17 +5	Aluminium 40 +10

Commissioning

Principles

- The valve has already been tested for leakage and strength by the manufacturer.
- The valve and the system into which it is installed, may only be commissioned if they have been checked, with due regard to the intended mode of operation, for proper condition as to assembly, installation, set-up conditions and safe functioning.
- After mounting and initial start-up according to EN 378-2 check again for leakage and strength and an effective corrosion protection.

Steps of commissioning

- Check the system for leakage and resistance to pressure by suitable means (e.g. helium, dry nitrogen).



DANGER!

Danger of bursting.
Most serious injuries possible.
The test pressure must not exceed the maximum allowable pressure (PS).
Strictly observe the safety information (e.g. EN 378).

- The application of an anticorrosive coating that suits the operating conditions is absolutely necessary for steel valves (valve series S and 6kt19) and may be necessary for stainless steel valves (series E and E_NH3). Make sure that the manufacturer's instructions remain legible.



CAUTION!

Delayed failure due to corrosion possible.
Serious injuries and failure of system during operation possible.
Apply a suitable anticorrosive coat.



ATTENTION!

Loss of product conformity due to loss of lettering.
Loss of warranty.
Lettering must be legible.

- Evacuating and filling the system with refrigerant.



DANGER!

Danger of bursting if operated beyond the technical parameters.
Most serious injuries possible.
Observe the technical parameters of the valve.
Avoid excessive filling of the system with refrigerant.

- Depending on the intended condition the spindle must be fully opened or fully closed. Before moving the spindle, loosen the stuffing box by ¼ turn. After the spindle has been moved tighten the gland with the required torque (leakage check). Thereafter, screw on the protective spindle cap. (torques see "Mounting")



WARNING!

Exceeding the tightening torques can lead to damage.
Serious injuries and system failure during operation possible.
Observe the torques.

- Upon initial commissioning check the pipes for any abnormal vibration and record the operating data.



CAUTION!

Cracks of the piping and the valve due to dynamic loads possible.
Injuries and system failure during operation possible.
Avoid heavy vibrations. Take safety measures if need be.

Operation, Maintenance and Repair

Principles

- The valve is maintenance-free.
- As part of the regular system inspection it should be checked for corrosion/damage/tightness and operability and its proper condition restored if necessary.

	WARNING!
	<p>Media contact possible, contact with hot/cold surfaces. Burns, frostbites. Wear personal protective equipment during maintenance and inspections as prescribed by national regulations.</p>

- If the valve spindle is to be operated for system maintenance, carefully remove the protective spindle cap.

	WARNING!
	<p>Protective spindle cap is pressure-tight and may be pressurized. Serious injuries possible. Slowly remove the cap. Allow any service fluid escape from inside the cap if necessary.</p>

If it is not possible to achieve a pressure compensation, firmly screw the protective spindle cap again and apply the prescribed torque. If so, it indicates a malfunction of the valve and the system has to be stopped without delay (see Repair chapter).

- Depending on the intended condition the spindle must be fully opened or fully closed. Before moving the spindle, loosen the stuffing box by ¼ turn. After the spindle has been moved tighten the gland with the required torque (leakage check). Thereafter, screw on the protective spindle cap. (torques see "Mounting")

	WARNING!
	<p>Exceeding the tightening torques can lead to damage. Serious injuries and system failure during operation possible. Observe the torques.</p>

Handling the service connections

- Depending on the configuration, the valve can have lockable and/or **non**-lockable service connections (see chapter "Operating principle").
- Lockable service connection:

When the spindle is fully opened, the back sealing achieves a separation of the connection from the circuit. This means that temporary service devices can be connected. Due to the principle, a small amount of the operating medium with corresponding pressure remains in the cavity from the back sealing to the connection, which escapes when the connection is opened. If pressure cannot be compensated within a short time, the connection must be closed immediately!

	CAUTION!
	<p>Escape of slight amounts of operating fluid possible. Minor, reversible injury cannot be excluded. Carefully open the connection. Wear personal protection equipment.</p>

- Non-lockable service connection:

Whatever the spindle position, **no** separation of the connection from the circuit is achieved. This means that it is only intended for use with permanently connected safety devices / pressure gauges.

	DANGER!
	<p>The non-lockable service connection pressurized permanently. Serious injury caused by loose parts and escape of greater amounts of operating fluid possible. The system should be depressurized for any work on the non-lockable service connection.</p>

Repairs

- If a repair to the valve is necessary, the system must be switched off, the refrigerant must be removed from the system (or system section) in an environmentally friendly manner and the system (or system section) must be ventilated.

	DANGER!
	<p>Refrigerant may escape. Leaking refrigerant may cause most serious injuries. For repairs the system must have the right temperature, free from refrigerant and sufficiently ventilated.</p>

- For repairs use no other than original spare parts. If it is not possible to repair the valve, it must be replaced.

	WARNING!
	<p>Valve damage due to defective spare parts/mounting. Avoidable serious injuries and system failure possible. Use no other than original spare parts for repairs.</p>

- Install / commission according to these instructions. It is imperative to carry out another leakage and strength test. No warranty is accepted by AWA for tightness in case of repair.

Dismantling and Disposal

Principles

- To dismantle the valve, shut off the system, remove the refrigerant from the system (or system section) in an environmentally friendly manner and sufficiently vent the system (or system section).

	DANGER!
	<p>Refrigerant may escape. Leaking refrigerant may cause most serious injuries. For repairs the system must have the right temperature, free from refrigerant and sufficiently ventilated.</p>

	WARNING!
	<p>Media contact possible, contact with hot/cold surfaces. Burns, frostbites. Wear personal protective equipment during maintenance and inspection as prescribed by national regulations.</p>

- The valve and its components can be recycled:

Valve body:	steel scrap / stainless steel scrap
Protective spindle cap:	plastics / aluminium
Dust cap:	plastics (PE)
PTFE-Rotalock seal:	plastics (PTFE); CAS number: 9002-84-0 (observe country-specific regulations for disposal if necessary)



Armaturenwerk Altenburg GmbH

Am Weißen Berg 30
D-04600 Altenburg
Germany

Telephone +49 (0) 3447-893-0
Telefax +49 (0) 3447-811-10

Internet: <http://www.awa-armaturenwerk.de>
E-Mail: info@awa-armaturenwerk.de

Subject to change as of: 03.2022
Document 90000715 Revision 01