

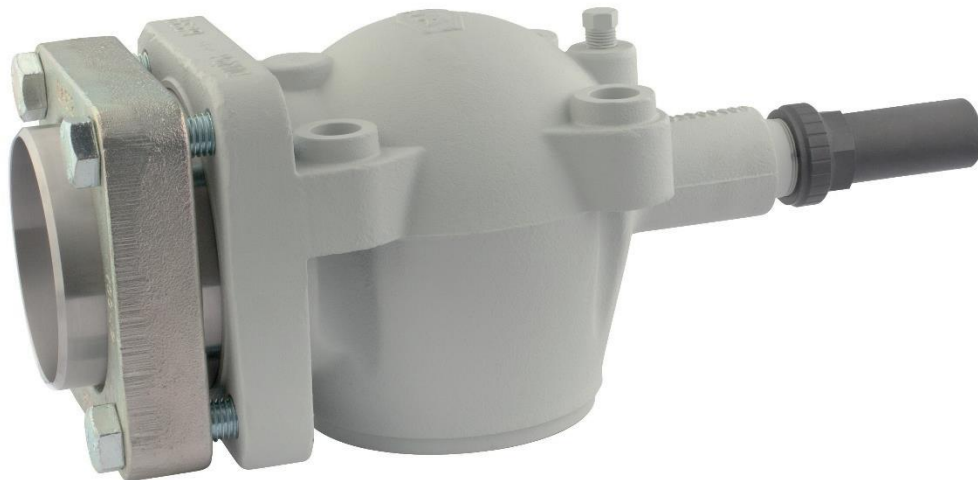

Operating Instructions
in compliance with
Pressure Equipment Directive 2014/68/EU
and
Pressure Equipment (Safety) Regulation 2016,
UK Statutory Instrument 2016 No. 1105

Cast iron valve Compressor



Please read these operating instructions carefully to ensure a safe operation and keep the same for further use.

© 2022 Armaturenwerk Altenburg GmbH | Am Weißen Berg 30 | 04600 Altenburg, Germany



Table of content

Safety.....	4
Authorized personnel.....	4
Residual hazards.....	4
Symbols used for safety information	4
General safety information	5
Other information	5
Description of valve	6
Types (possible combinations of connections).....	6
Operating principle	7
Product description.....	7
Identification	8
Technical parameters.....	8
Design features	9
Transport and Storage.....	9
Mounting.....	10
Principles	10
Mounting preparation.....	10
Connecting the system and compressor	11
Commissioning	12
Principles	12
Steps of commissioning.....	13
Operation, Maintenance and Repair	13
Principles	13
Handling the service connections.....	14
Repairs	15
Dismantling and Disposal.....	15
Principles	15

Safety

The Cast iron valve Compressor, hereinafter referred to as valve, is designed for use in refrigeration/air conditioning systems, hereinafter referred to as systems. It may only be put into service if installed in the system unchanged in accordance with these instructions and in its entirety is in compliance with the statutory provisions.

The valve incorporates state-of-the-art technology and has been built according to the applicable regulations. Great value has been set upon the user's safety.

These operating instructions are integral part of the contract and shall be kept throughout the entire life of the valve.

Authorized personnel

Only trained and instructed personnel shall be allowed to do any work on the valve and system. As regards the qualification and expertise of the personnel the applicable rules and guidelines shall apply.

Residual hazards

Unavoidable residual dangers may emanate from the valve. Every person working on this device shall therefore carefully read these instructions!

To be observed are for example:

- the generally accepted safety regulations,
- EC directives,
- Norms (e.g. EN 378) and all national provisions.

Symbols used for safety information



DANGER!

Instructions on preventing imminent serious dangers to persons.
Imminent most serious injuries or death as a possible consequence.
Any non-observance may lead to an immediate failure of the valve.



WARNING!

Instructions on preventing potential serious danger to persons.
Avoidable serious to very serious injuries or death a possible consequence.
Any non-observance may cause the valve to fail.



CAUTION!

Instructions on preventing a minor danger to persons.
Minor, reversible injuries cannot be excluded.
Any non-observance may lead to a medium-term failure of the valve.



ATTENTION!

Instructions on preventing potential damage to equipment.
Minor, reversible injuries cannot be excluded.
Any non-observance may lead to a medium-term failure of the valve.

General safety information

These operating instructions are based on the safety requirements of EN 378-2 and EN 12284.

Instructions to prevent hazards in all cycles of service life:

**DANGER!**

Risk of bursting if operated beyond the technical parameters.
Most serious injuries and immediate system failure possible.
Observe the technical parameters.

**WARNING!**

Damage due to improper handling.
Serious injuries and system failure possible.
Never use valves as transport, lifting or lashing points.

**WARNING!**

Any non-observance of the instructions may cause the valve to fail.
Avoidable serious to very serious injuries or death possible.
Installation, operation and maintenance by authorized personnel only.

**WARNING!**

Risk of service fluid to be released.
Depending on the kind of service fluid serious to very serious injuries or death possible as a consequence.
Wear personal protective equipment (e.g. respirators, gloves).

**CAUTION!**

Very cold or very hot surface temperatures possible.
Frostbites/burns possible.
Wear personal protective equipment (e.g. respirators, gloves).

Other information

The information contained herein represents to the best of our belief our knowledge at the time when these instructions were prepared. It shall serve as code of practice to ensure a safe handling of the valve in transport, storage, installation, commissioning, maintenance and dismantling/disposal. A final decision as to whether the valve suits the purpose is to be taken by the user. This information shall not be deemed a warranty of quality.

Any modification of the valve and operation under other than the prescribed parameters shall not be allowed and will result in the loss of the conformity declaration and all liability claims.

Description of valve

Types (possible combinations of connections)

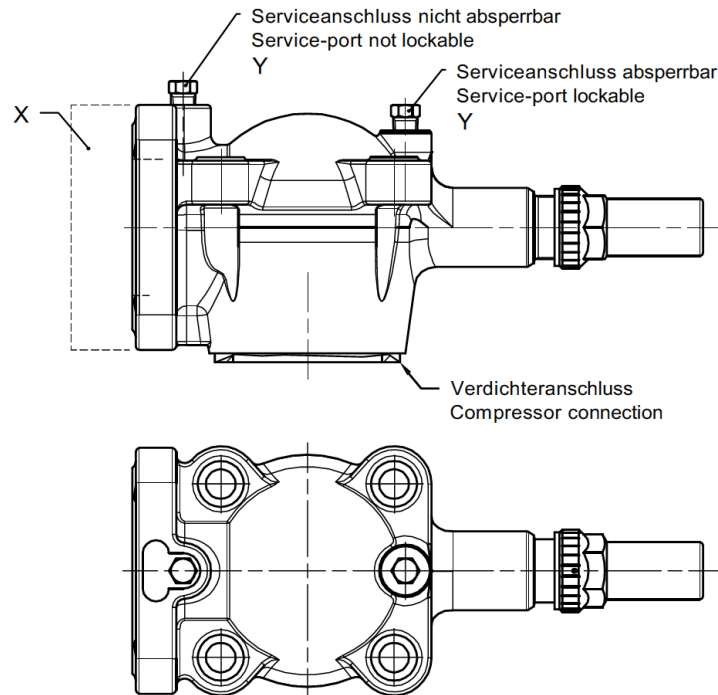

Varianten für Anlagenanschluss X
Variants for System connection X

A
Flansch mit Lötbuchse
Flange with solder bush

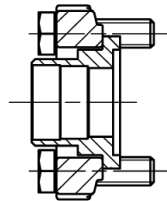

B
Flansch mit Schweißbuchse
Flange with welding bush

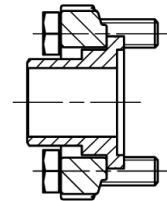

Varianten für Serviceanschluss Y
Variants for Service port Y

C
Blindstopfen
Plug



D
Serviceanschluss
Service port
SAE 1/4"



E
Serviceanschluss
Service port
CELØ6

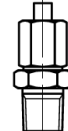

The valves come with a compressor connection and a system connection with flange and bush. Installation dimensions can be gathered from the AWA product catalogue and technical documents respectively. The connecting options A to E are explained in more detail in "Design features".

Operating principle

Spindel auf Ventilsitz geschlossen
Spindle position on valve seat closed

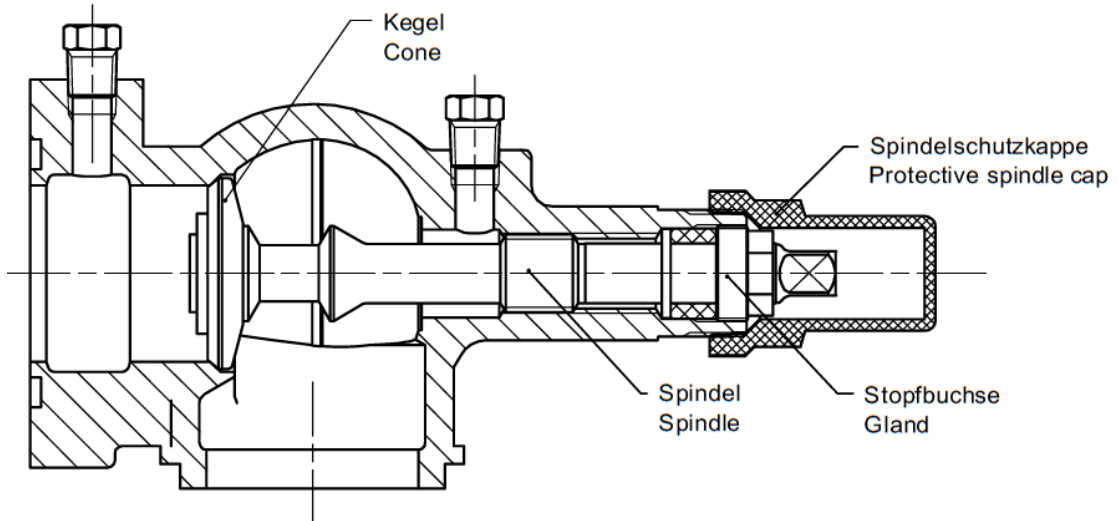

Spindel geöffnet
Spindle position open

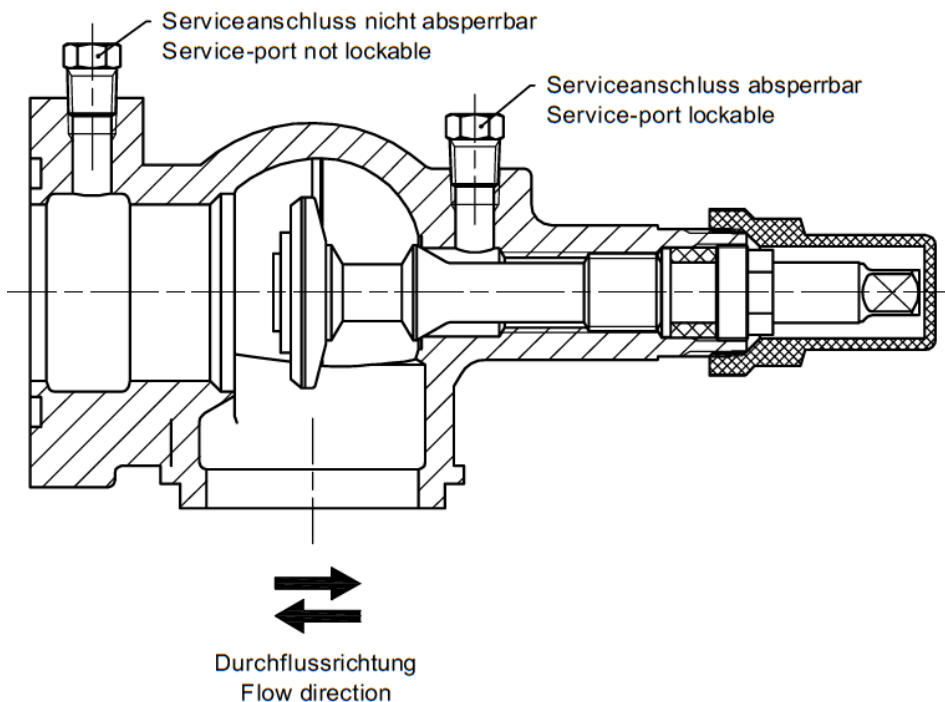

Product description

The valve is intended for direct mounting on compressors for refrigeration or air conditioning systems. The valve is a manual shut-off valve.

The flow direction are optional.

The valve is in compliance with EN 12284, the Pressure Equipment Directive 2014/68/EU and the Pressure Equipment (Safety) Regulation 2016, UK Statutory Instrument 2016 No. 1105.



Identification

The valve is marked (casted-in and/or marking) in accordance with EN 12284 on the valve body:

- Manufacturer's logo
- Maximum allowable pressure PS in bar
- Nominal size DN in mm
- Housing material
- Date of manufacture
- UL-mark
- **CE** / **UKCA** mark and identification number of the notified body (if applicable)

Technical parameters

Allowable pressure/ temperature / service fluids:

Maximum allowable pressure PS: PS 35bar PS 26bar
Allowable temperature TS: TS -40 ... 140°C TS' -40 ... -20°C
Permitted service fluids:

Standard: Refrigerants acc. to EN 378-1 (2016) Safety Group A1 to A3 and B1
(PED Fluid Group 1 and 2)
on request: Refrigerants acc. to EN 378-1 (2016) PED Fluid Group 1 and 2

In addition, other service fluids, temperatures or pressures may be permitted by agreement. This is explicitly stated in the technical documentation for the product.

Leakage test:

according to DIN 8964-3 (<4,1 g/a R-134a at 10bar)

Strength test:

according to EN 12284 at 1.43fold PS

Cleanliness of interior:

according to DIN 8964-1

Classification pursuant to Pressure Equipment Directive 2014/68/EU and PE(S)R 2016:

Valve DN32 to DN100 Category II

For valves with other service fluid, temperatures or pressures, other classifications may apply. This is indicated in the technical documentation

Approval under UL 207

The valves are UL 207 approved for the US and Canadian market.

Design features

- The material of the valve components and the manufacturing method are selected in conformity with the EN 12284, the Pressure Equipment Directive 2014/68/EU and the Pressure Equipment (Safety) Regulation 2016 thus guaranteeing the reliability for the operating range indicated.
- The valve housing material cast iron (EN-GJS-400-18-LT) provides for both a high degree of media compatibility and corrosion resistance. By agreement and with restrictions on the service fluids, the use of valve housings made of GJL-250 is possible.
- The flow can pass the valve in both directions. The recommended flow direction with optimum cv-value is the flow onto the valve cone.
- The valve cone with soft seal is rotatably attached to the spindle.
- The valve spindle is designed with a square for actuation and has a metal back sealing function. The latter is only operative when the valve is fully open. The sealing between spindle and housing is by a graphite packing and adjustable gland seal.
- The valve comes as standard with a plastic high-density protective spindle cap. Depending on the admissible operating parameters the valve has a protective spindle cap of aluminum. Both types of protective spindle cap are provided with a relief hole.
- The system connection is designed as a flange connection with tongue and groove system, gasket and a bushing. The valve can be supplied with or without a system connection.
- The compressor connection is specially adapted to the connection conditions of the various manufacturers.
- Types of connection:
 - Connection "A" Flange with solder bush** – Brazed capillary connection to render a brazed joint with copper pipes according to EN 12735-1 for dia. 22 to 108mm and relevant inch dimensions. Designed as connection for insertion of a copper pipe (ODS).
 - Connection "B" Flange with welding bush** – Welded connection for use of pipes according to EN 10220 for dia. 26,9 to 114,3mm and relevant inch-type dimensions. Designed as a butt weld connection (WB) or as combined welding/soldering connection (W/ODS) for the optional making of a brazed joint with copper pipes according to EN 12735-1.
 - Connection "C"** – Detachable threaded connection with NPTF thread acc. to ANSI B1.20.3, designed as connection with female thread and plug.
 - Connection "D"** – Detachable threaded connection with 90° sealing cone according to flare connection principle (SAE J516, DIN 3866), designed as connection with male threads SAEM 1/4" and flare cap.
 - Connection "E"** – Detachable connection for compression joints and O-ring screw connections according to DIN 2353, EN ISO 8434 or other.
- The valve comes with temporary corrosion protection (manganese phosphating, zinc coat, prime coat). This kind of coating ensures protection against corrosion until installation if handled and stored in dry condition.
- The service-friendly design makes it possible to purchase spare parts (protective spindle cap, gaskets, flange, bush) separately.

Transport and Storage

Transport the valve by closed means of transport in the original packing protected against weather influences and store it in dry rooms.

Mounting

Principles

- The valve shall be arranged in the system so that it can be properly installed, operated and maintained.

	DANGER!
	Damage to valve possible.
	Serious injuries and system failure during operation possible.
	Valve to be installed without additional loads (forces, vibrations etc.). Never use the valve as fixing points of pipes.

- The removal space for the spindle actuation and the removal of the protective spindle cap is to be provided with at least 100mm.
- A safe operation of the spindle (opening and shutting off) with the required tightening torques (torque spanner) must be possible.
- The flow can pass the valve in both directions.
- The valve should be installed with the valve spindle in a horizontal position or with the valve spindle vertical upwards.
- The valve must be integrated into the pipe on both sides. An outlet side open to the outside is not permitted!
- Only authorized personnel shall be allowed to mount the valve.

	DANGER!
	Any non-observance of these instructions may cause the valve/system to fail.
	Most serious injuries and death possible.
	Mounting and operation by personnel trained in refrigeration systems only.

- No modifications of the valve permitted. If modifications become necessary, they have to be agreed with the manufacturer in writing prior to mounting.

	WARNING!
	Product features may change.
	Avoidable serious to very serious injuries or death possible.
	Any modification of the valve has to be agreed with manufacturer in advance.

Mounting preparation

- When supplied the valve is closed and may come with additional protective means for transport. To avoid corrosion inside the valve and contamination, such protective means should be removed shortly before mounting.

	ATTENTION!
	Damage to interior components possible.
	Malfunction due to oxidation/contamination of interior components.
	Wait to remove the transport protection until shortly before mounting.

- Only for connection A & B: Dismantle connection parts (flange, bushing, seal, screws). These components are to be stored protected against damage until required later.

Connecting the system and compressor

- Make the connections in compliance with the following connection-specific principles:

The pipe must be of a dimension that fits the valve. If not, use adapters.

Make sure there is no mechanical restraint.

- **For soldered/welded connections:**

Prepare the system connections so (bare metal and grease-free) that a high-quality joint can be achieved.

Scavenge the relevant pipe sections with shielding gas during soldering / welding.

Then, cool down the system connection in the air.

Clean the pipe connection made. Flux material residues from the soldering process are very corrosive and may cause long-term damage.



WARNING!

Damage of components due to excessive heating possible.
 Serious injuries and system failure possible during operation.
 Direct the heat source away from adapter (component temperature max. 820°C)!



WARNING!

Damage of components (e.g. cracking) due to rapid cooling possible.
 Serious injuries and system failure possible during operation.
 Allow joint to cool down in the air.



CAUTION!

Risk of increased corrosion and component damage.
 Serious injuries and system failure possible during operation.
 Properly clean the joint after joining.

- **For screwed connections:**

Make sure that the compressor and system connections are in conformity in terms of type and dimensions and that the required sealing elements are used.

Mount the valve on the compressor using the mounting material specified by the compressor manufacturer. Then make the flange connection to the system.

Initially screw the nuts/bolts hand-tight. Then tighten the nuts/bolts crosswise in at least 2 stages to the specified tightening torque.



WARNING!

Excessive torques or non-observance of the mounting order may cause failures delayed in time.
 Serious injuries and system failure possible during operation.
 Observe the torques and mounting order.

- **For service connections:**

Depending on the configuration, the valve can have lockable and/or non-lockable service connections (see chapter "Operating principle").

If necessary, use the service connections for the installation of further system components.

If available, use the wrench flats directly arranged at the connection to apply the necessary torques. The torques of the relevant screw connections have to be strictly observed.



WARNING!

Potential malfunction of safety devices.
 Serious injuries and system failure possible in subsequent operation.
 Never connect safety devices to the lockable service connection.



- Depending on the intended condition the spindle must be fully opened or fully closed. Before moving the spindle, loosen the stuffing box by $\frac{1}{4}$ turn. After the spindle has been moved tighten the gland with the required torque and screw on the protective spindle cap.
- The following torques apply to the valve assembly (Nm):

Valve size	Spindle square	Spindle closed	Spindel open	Gland	Protective spindle cap	
					Plastic	Aluminium
DN 32	3/8"	30 +5	17 +5	17 +5	14 +2	40 +10
DN 40	3/8"	40 +10	30 +10	17 +5	20 +5	60 +10
DN 50	3/8"	60 +10	50 +10	17 +5	20 +5	60 +10
	1/2"	60 +10	50 +10	50 +10	30 +5	60 +10
DN 80	1/2"	80 +10	50 +10	50 +10	30 +5	80 +10
DN 100	1/2"	100 +10	50 +10	50 +10	30 +5	80 +10

The following torques apply to the bolts of the system/compressor connection:

Thread	Torque in Nm
M8	25 ±5
M10	50 ±5
M12 or 1/2 UNC	85 ±5
M16 or 5/8 UNC	150 ±10
M18, M20 or 3/4 UNC	200 ±10

The following torques apply to the service connection (Y):

Thread	Torque in Nm
1/8 -27 NPTF	15 +5
1/4 -18 NPTF	20 +20

For the NPTF connection thread sealants may be used.

- For connection variants or connection sizes not listed here, the tightening torques or a description of the installation procedure are listed in the technical documentation or in a separate supplementary sheet.

Commissioning

Principles

- The valve has already been tested for leakage and strength by the manufacturer.
- The valve and the system into which it is installed, may only be commissioned if they have been checked, with due regard to the intended mode of operation, for proper condition as to assembly, installation, set-up conditions and safe functioning.
- After mounting and initial start-up according to EN 378-2 check again for leakage and strength and an effective corrosion protection.

Steps of commissioning

- Check the system for leakage and pressure resistance by suitable means (e.g. helium, dry nitrogen).

	DANGER!
	Danger of bursting. Most serious injuries possible. The test pressure must not exceed the maximum allowable pressure (PS). Strictly observe the safety information (e.g. EN 378).

- The application of an anticorrosive coating that suits the operating conditions is absolutely necessary. Make sure that the fabrication data remain legible.

	CAUTION!
	Delayed failures due to corrosion possible. Serious injuries and system failure during operation possible. If necessary apply a suitable anticorrosive coating.

- Evacuating and filling the system with refrigerant.

	DANGER!
	Danger of bursting if operated beyond the technical parameters. Most serious injuries possible. Observe the technical parameters of the valve. Avoid excessive filling of the system with refrigerant.

- Depending on the intended condition the spindle must be fully opened or fully closed. Before moving the spindle, loosen the stuffing box by ¼ turn. After the spindle has been moved tighten the gland with the required torque (leakage check). Thereafter, screw on the protective spindle cap. (torques see “Mounting”)

	WARNING!
	Exceeding the tightening torques can lead to damage. Serious injuries and system failure during operation possible. Observe the torques.

- Upon initial commissioning check the pipes for any abnormal vibration and record the operating data.

	CAUTION!
	Cracks of the piping and the valve due to dynamic loads possible. Injuries and system failure during operation possible. Avoid heavy vibrations. Take safety measures if need be.

Operation, Maintenance and Repair

Principles

- The valve is maintenance-free.
- As part of the regular system inspection it should be checked for corrosion/damage/tightness and operability and its proper condition restored if necessary.

	WARNING!
	Media contact possible, contact with hot/cold surfaces. Burns, frostbites. Wear personal protective equipment during maintenance and inspections as prescribed by national regulations.

- If the valve spindle is to be operated for system maintenance, carefully remove the protective spindle cap.

WARNING!

Protective spindle cap is pressure-tight and may be pressurized.
 Serious injuries possible.
 Slowly remove the cap. Allow any service fluid escape from inside the cap if necessary.

If it is not possible to achieve a pressure compensation, firmly screw the protective spindle cap again and apply the prescribed torque. If so, it indicates a malfunction of the valve and the system has to be stopped without delay (see Repair chapter).

- Depending on the intended condition the spindle must be fully opened or fully closed. Before moving the spindle, loosen the stuffing box by ¼ turn. After the spindle has been moved tighten the gland with the required torque (leakage check). Thereafter, screw on the protective spindle cap (torques see "Mounting").uf

WARNING!

Exceeding the tightening torques can lead to damage.
 Serious injuries and system failure during operation possible.
 Observe the torques.

Handling the service connections

- Depending on the configuration, the valve can have lockable and/or non-lockable service connections (see chapter "Operating principle").
- Lockable service connection:

When the spindle is fully opened, the back sealing achieves a separation of the connection from the circuit. This means that temporary service devices can be connected. Due to the principle, a small amount of the operating medium with corresponding pressure remains in the cavity from the back sealing to the connection, which escapes when the connection is opened. If pressure cannot be compensated within a short time, the connection must be closed immediately!

CAUTION!

Escape of slight amounts of operating fluid possible.
 Minor, reversible injury cannot be excluded.
 Carefully open the connection. Wear personal protection equipment.

- Non-lockable service connection:

Whatever the spindle position, **no** separation of the connection from the circuit is achieved. This means that it is only intended for use with permanently connected safety devices / pressure gauges.

DANGER!

The non-lockable service connection pressurized permanently.
 Serious injury caused by loose parts and escape of greater amounts of operating fluid possible.
 The system should be depressurized for any work on the non-lockable service connection.

Repairs

- If a repair to the valve is necessary, the system must be switched off, the refrigerant must be removed from the system (or system section) in an environmentally friendly manner and the system (or system section) must be ventilated.

	DANGER!
	Refrigerant may escape.
	Leaking refrigerant may cause most serious injuries.
	For repairs the system must have the right temperature, free from refrigerant and sufficiently ventilated.

- For repairs use no other than original spare parts (valve, gasket, flange, bush). If the valve cannot be repaired, it must be replaced.

	WARNING!
	Valve damage due to defective spare parts/mounting.
	Avoidable serious injuries and system failure possible.
	Use no other than original spare parts for repairs.

- Install / commission according to these instructions. It is imperative to carry out another leakage and strength test. No warranty is accepted by AWA for tightness in case of repair.

Dismantling and Disposal

Principles

- To dismantle the valve, shut off the system, remove the refrigerant from the system (or system section) in an environmentally friendly manner and sufficiently vent the system (or system section).

	DANGER!
	Refrigerant may escape.
	Leaking refrigerant may cause most serious injuries.
	For repairs the system must have the right temperature, free from refrigerant and sufficiently ventilated.

	WARNING!
	Media contact possible, contact with hot/cold surfaces.
	Burns, frostbites.
	Wear personal protective equipment during maintenance and inspection as prescribed by national regulations.

- The valve and its components can be recycled:

Valve, flange:	cast iron scrap
Bush:	steel scrap or brass
Protective spindle cap:	plastics / aluminium
Dust caps:	plastics (PE)



Armaturenwerk Altenburg GmbH
Am Weißen Berg 30
04600 Altenburg

Telephone +49 (0) 3447-893-0
Telefax +49 (0) 3447-811-10

Internet: <http://www.awa-armaturenwerk.de>
Email: info@awa-armaturenwerk.de

Subject to change as of: 03/2022
Document 90000708 Revision 03